

# METRICA

MADE TO MEASURE



SELEÇÃO 2025  
PROMOÇÃO

# METRICA ALU 60

- Alcance **60 m**
- **Corpo de Alumínio** de alta qualidade
- Função de **pintor**: permite-lhe medir as superfícies das paredes de uma ou mais divisões (por Ex., para definir as quantidades de materiais necessárias)
- **Dígitos Grandes de Alta Definição (HD)**
- **Bateria Li-ion recarregável** (USB-C)
- Indicador de carga
- Precisão +/- **2 mm**
- Grau de Proteção **IP 54**



CÓD.		€	
61661	60 m	119,00	89,00

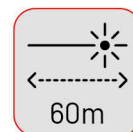

# METRICA FLASH MINI ALU 30

- Alcance **30 m** (interno)
- **Ponto Laser Vermelho**
- **Corpo de Alumínio** de alta qualidade
- Medida do dispositivo 85 x 23 x 11,5 mm
- Medição contínua com visualização dos valores Mínimo e Máximo
- Opção de medição desde a parte frontal ou traseira do dispositivo e escolha de unidades (polegadas, pés, etc.)
- **Bateria Li-ion recarregável** (USB-C)
- Inclui Cabo de Carga USB
- Indicador de carga
- Precisão +/- **5 mm**
- Grau de Proteção **IP 54**



CÓD.		€	
61660	30 m	60,25	50,25

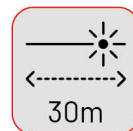

## DOUBLE ALU 60 + 60 m

- Alcance **60 + 60 m** (interno)
- Modelo **Profissional** com corpo de alumínio
- Equipado com um **ímã** na parte de trás para posicionar em estruturas metálicas
- Função de **pintor**
- Cálculo automático de áreas, adições, subtrações e volume.
- Medição contínua com indicação dos valores Mínimo e Máximo
- **Tecnologia HSA**: Assistente de som, ajuda a facilitar uma medição mais correcta graças ao sinal sonoro emitido quando o instrumento é posicionado  $\pm 2^\circ$  horizontalmente
- **Bateria Li-ion recarregável** (USB-C)
- Precisão de medição  $\pm 2$  mm (para cada feixe)
- Grau de Protecção **IP 54**

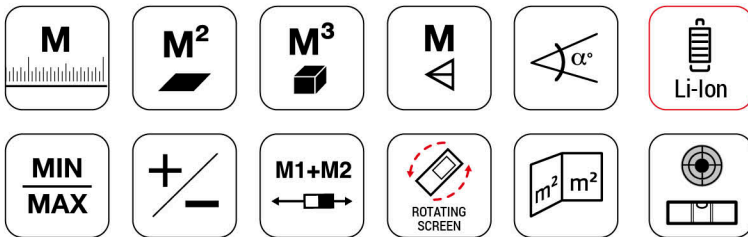
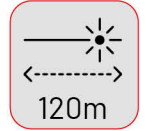

### TECNOLOGIA HSA

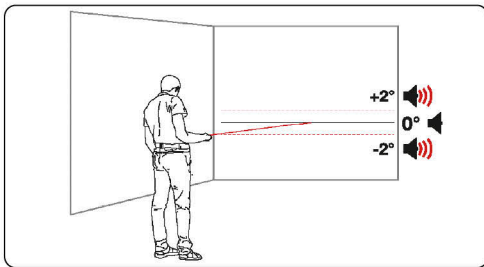

### MEDIÇÃO EM PÉ

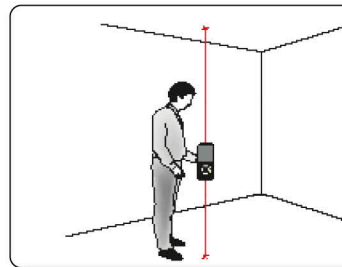

### MEDIR NO CENTRO

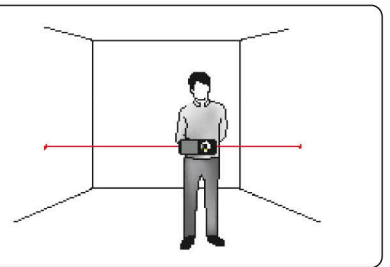

### ECRÃ COM FUNDO CLARO OU PRETO

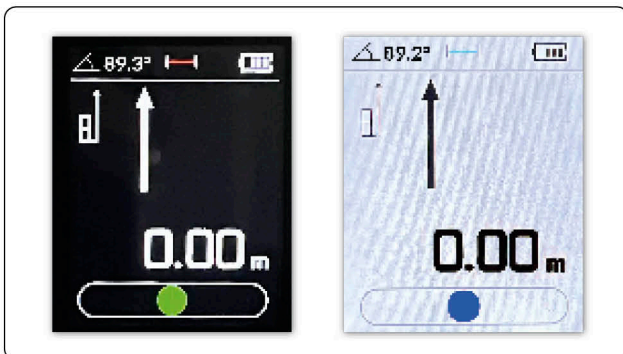

cód.		€	
61662	60 m	171,00	135,00

## METRICA GO 40

- Alcance **40 m**
- 2 Funções de **Pitágoras**
- Inclui bolsa e pilhas
- Indicador de carga
- Precisão +/- **2 mm**
- Grau de Proteção **IP 54**

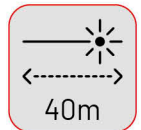

cód.		€	
<b>61134</b>	40 m	<b>67,75</b>	<b>54,50</b>

## METRICA ONE 30

- Alcance **30 m**
- Medidas de superfícies e volumes
- Compacto, prático e fácil
- Medição **direta e contínua**
- Grande ecrã retroiluminado com números grandes
- Indicador de carga
- Precisão +/- **2 mm**
- Grau de Proteção **IP 54**



**INCLUI  
ALÇA, ESTOJO  
E PILHAS**

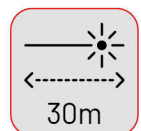

cód.		€	
<b>61120</b>	30 m	<b>62,95</b>	<b>53,00</b>

## METRICA FLASH 30, 50 E 80

- 4 funções de **Pitágoras**
- Medições diretas, contínuas e diagonais
- Função Mínimo e Máximo com Memória
- **FLASH 80** (Ref **61180**): Funções adicionais 6 Pitágoras, Inclínometro, Bolha eletrónica e Pilhas recarregáveis (Micro USB)
- Precisão +/- **2 mm**
- Rosca para tripé de 1/4"
- Grau de Proteção **IP 54**



**INCLUI  
ALÇA, ESTOJO  
E PILHAS**

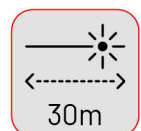

**Cód. 61130**

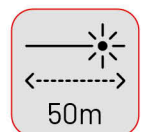

**Cód. 61150**

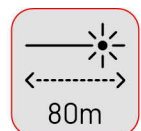

**Cód. 61180**

cód.		€	
<b>61130</b>	30 m	<b>97,85</b>	<b>60,30</b>
<b>61150</b>	50 m	<b>118,30</b>	<b>71,95</b>
<b>61180</b>	80 m	<b>172,05</b>	<b>102,30</b>



## FLASH DUPLO LASER 50 INCLIGRAD

- Alcance **30 m** (laser frontal) + **20 m** (laser traseiro)
- Ecrã a cores de 4 linhas de alta visibilidade autoajustável horizontal e vertical
- **Dois lasers que permitem medições SEM necessidade de se abaixar**
- Inclinómetro
- **50 Memórias**
- Desenhado para leituras rápidas e estimativas fáceis de cálculo de áreas / quantidades de materiais (Ex.: Pintura)
- **Bateria Li-ion recarregável**
- Indicador de carga
- Precisão +/- **3 mm**
- Grau de Proteção **IP 54**

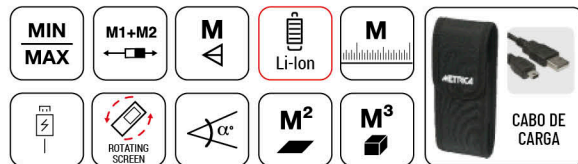

CÓD.		€
<b>61114</b>	50 m	<b>129,05 98,05</b>

Composição 6 x Cód. 61114 + Cód. DOUBLE EXPO  
Complementar com a primeira encomenda

CÓD.			€
<b>89296</b>	18 x 27 x 11 cm	1	<b>774,30 588,30</b>



**METRICA FLASH**  
DOUBLE LASER

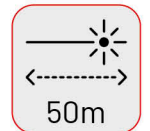

CÓD. EXPO DOUBLE

## METRICA FLASH mini 30

- Alcance **30 m**
- Ecrã a 4 cores de alta visibilidade
- **50 Memórias**
- Modo Stand-by Automático
- Indicador de carga
- **Bateria Li-ion recarregável**
- Precisão +/- **3 mm**
- Grau de Proteção **IP 54**

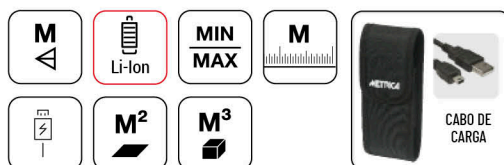

CÓD.		€
<b>61110</b>	30 m	<b>76,90 56,00</b>

Composição 6 x Cód. 61110 + Cód. EXPO MINI  
Complementar com a primeira encomenda

CÓD.			€
<b>89295</b>	18 x 27 x 11 cm	1	<b>461,40 336,00</b>

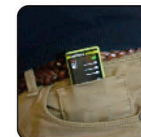
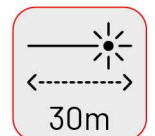

CÓD. EXPO MINI

# 2025

# PROMOÇÃO

## METRICA FLASH POINT2POINT 60

- Alcance **60 m**
- **Point2Point**: Medição de um ponto a outro em plano horizontal
- **Roda de medição** para medir circunferências e volumes de objetos rapidamente
- Projeta uma **linha laser fixa**
- Inclinómetro
- **Visor (HD) de 2,4"** que se ajusta automaticamente horizontal e vertical
- Inclui bolsa e pilhas
- Precisão +/- **2 mm**
- Grau de Proteção **IP 65**



RODA DE MEDIÇÃO POR CONTACTO



ROTAÇÃO DO ECRÃ



WATER PROOF  
**IP 65**



60m



INCLUIDO



MONTAGEM EM TRIPÉ (NÃO INCLUIDO)



CÓD.		€	
61260	60 m	<del>195,20</del>	135,20

## Point2Point



- ROTATING SCREEN
- WHEEL MEASUREMENT
- VISIBLE LINE
- P2P
- VOCAL READING

## METRICA FLASH GREEN 60 E 100 M

- Novo feixe laser **Verde** altamente visível ao ar livre e incidência do sol
- Ecrã luminoso para facilitar a visualização no exterior
- Função de **pintor**: mede a superfície da parede de uma ou mais divisões (por Ex., para determinar a quantidade de materiais)
- Inclinómetro
- **30 Memórias**
- Medição instantânea e contínua
- **Tecnologia HSA**: Assistente de som, ajuda a facilitar uma medição mais correcta graças ao sinal sonoro emitido quando o instrumento é posicionado  $\pm 2^\circ$  horizontalmente
- Bateria de Li-ion recarregáveis (USB) incluída
- Inclui Bolsa e Cabo de Carga
- Precisão +/- **2 mm**
- Grau de Proteção **IP 54**





HSA TECHNOLOGY  
+2°  
0°  
-2°



1/4"



CÓD.		€	
61060	60 m	<del>150,55</del>	111,45
61100	100 m	<del>181,20</del>	138,85



INCLUIDO



SUPORTE PARA TRIBE 1/4"



BATERIA Li-Ion 3.7 V 850 mAh



- WATER PROOF **IP 54**
- 60m
- Cód. 61060
- 100m
- Cód. 61100

# METRICA FLASH 300 Zoom

- Alcance **300 m**
- **Fotografias (HD) com medição**
- **Zoom** de 2x e 4x
- Ecrã a cores (HD) de 3 polegadas
- Brilho do ecrã tanto no interior como no exterior
- **100 Memórias**
- **Câmara** de busca de pontos de medição integrada
- Medição ponto-a-ponto (P2P)
- Sensor de inclinação de alta precisão
- **Tecnologia HSA:** Assistente de som, ajuda a facilitar uma medição mais correcta graças ao sinal sonoro emitido quando o instrumento é posicionado  $\pm 2^\circ$  horizontalmente
- **Carregamento por indução**
- Inclui 2 pilhas recarregáveis AAA Ni-Mh (USB)
- Precisão  $\pm 2$  mm
- Grau de Protecção **IP 65**

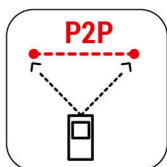
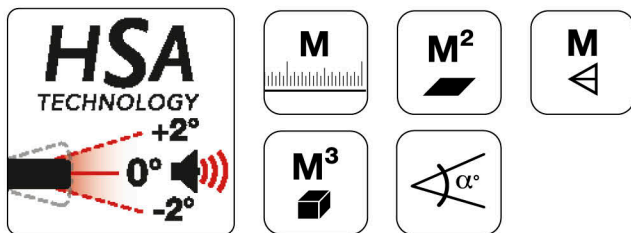

PONTO A PONTO

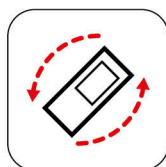

ECRÃ ADAPTÁVEL

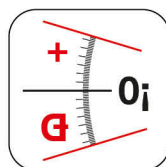

INCLINÓMETRO

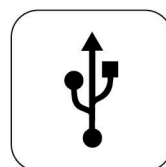

USB

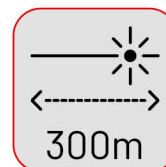

300m

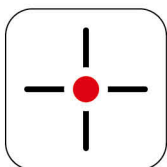

CÂMARA DE PESQUISA DE PONTOS



100 MEMÓRIAS IMAGENS

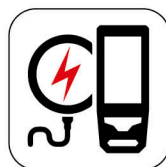

CARREGAMENTO POR INDUÇÃO



ALARME SONORO

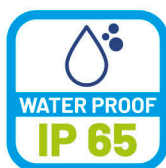

IMPERMEABILIDADE

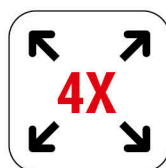

ZOOM 4X



Cód. 0980

OFERTA

X-ATO METRICA UTILITY

CÓD.		€	
61270	300 m	483,90	369,00

## METRICA FLASH c100

- **Câmara com visor** foca o ponto de medição
- Medidas de superfície e volumes
- 6 Funções de **Pitágoras**
- Inclinómetro e Bolha eletrónica
- Medição direta, contínua e diagonal
- Função Mínimo e Máximo
- **100 Memórias**
- Modo Stand-by Automático
- Micro-USB e baterias recarregáveis
- Indicador de carga
- Precisão  $\pm 2$  mm
- Grau de Proteção **IP 54**



### INCLUI CABO USB E BATERIAS RECARREGÁVEIS



CÓD.		€	
61186	100 m	337,65	219,20

## METRICA FLASH 120 zoom

- **Câmara zoom 4X com visor**
- **Foto** do ponto medido com memória de medição
- Gravação de **vídeo e voz** com memória
- **Função de pintor** com cálculo automático do perímetro do solo e das 4 paredes de uma divisão
- Inclinómetro **Digital Duplo** (horizontal e vertical)
- Função de medição contínua com valores Mínimo e Máximo sempre visíveis
- 7 Funções de **Pitágoras**
- Medição de Distâncias, Áreas e Volumes
- Adição e subtração
- **16 GB de memória interna**
- Baterias recarregáveis
- Inclui cabo de ligação ao PC / recarregamento
- Precisão  $\pm 2$  mm
- Grau de Proteção **IP 54**



### CAMERA ZOOM 4X



CÓD.		€	
61190	120 m	389,25	292,25

## PACK NÍVEL LASER CROSS GREEN

- Alcance **15 m ou 40 m** com Receptor (**não incluído**)
- Projecta uma linha verde horizontal e vertical autonivelante
- 3 ajustes de intensidade do raio
- Inclínável para pendentes
- Pack ideal para trabalhos simples e rápidos no interior
- Inclui Tripé de aço 1,5m com Bolsa e 2 Pilhas Alcalinas
- Grau de Proteção **IP 54**

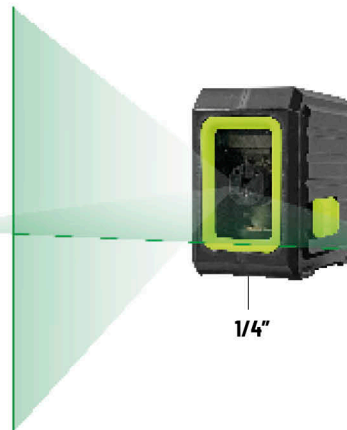
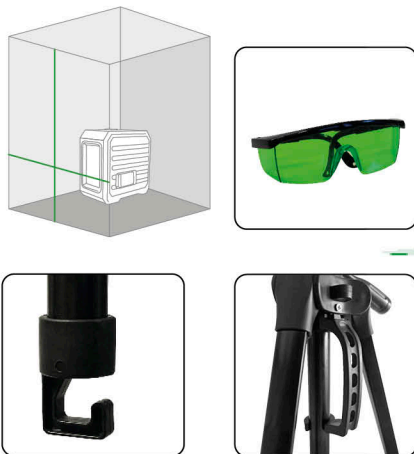

CÓD.		MEDIDA LASER	€	
61423	●	65 x 65 x 40 mm	80,65	69,45

## NÍVEL LASER 360° + 1V RED

- Alcance **30 m ou 60 m** com Receptor (**não incluído**)
- Laser Vermelho 360° horizontal e 1 vertical formando uma cruz
- Design compacto e prático
- Possibilidade de bloquear o laser
- Sistema de impulso sempre ativado para Receptor (**não incluído**)
- Ângulos de **90°**
- Rosca 1/4"
- Inclui Estojo e 4 Pilhas Alcalinas AA
- Grau de Proteção **IP 54**

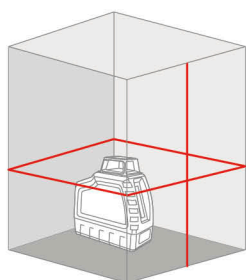

CÓD.		ALCANCE Ø*	ALCANCE COM RECEPTOR Ø*	€	
61424	●	30 m	60 m	128,00	111,45

\* feixe horizontal

## METRICA LASERBOX 360 + 1V + 2D GREEN

- Alcance **60 m ou 100 m** com Receptor (**não incluído**)
- Iman na parte frontal para fixar o laser ao solo
- Fácil de colocar contra o teto (menos de 1 cm)
- **Intensidade regulável do feixe laser** (3 Modos)
- Sistema de bloqueio integrado para evitar vibrações durante o transporte, os planos laser também podem ser projectados numa posição inclinada fixa
- Pode ser utilizado com Receptor (**Cód. 60749 não incluído**) graças à sua função de impulso
- Inclui Suporte de parede magnético ajustável, acessórios e Mala rígida
- **Bateria Li-ion recarregável** e Cabo incluído (USB-C)
- Grau de Protecção **IP 54**

**NEW**



WATER PROOF  
**IP 54**

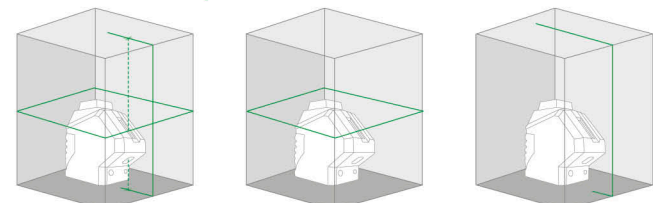
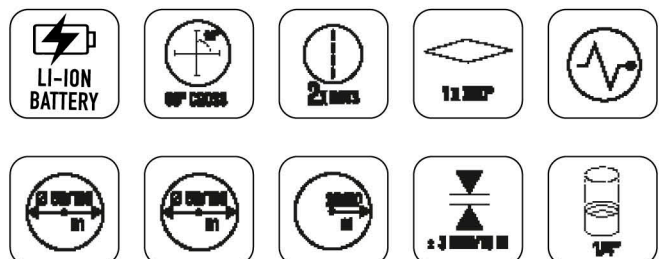

CÓD.		ALCANCE Ø*	ALCANCE COM RECEPTOR Ø*	€
<b>61375M</b>	●	60 m	100 m	<b>267,25 219,00</b>

\* feixe horizontal

## METRICA CROSS GREEN

- Alcance **30 m ou 50 m** com Receptor (**não incluído**)
- Nível de laser **verde**  
Projeta um **plano horizontal** e outro **plano vertical formando 1 cruz na parede**
- Uso interno / externo (Pode ser utilizado com Receptor **Cód. 60749 não incluído**)
- **Base magnética e tampa metálica** para fácil sobreposição
- **Bateria Li-ion recarregável** e Cabo incluído (USB)
- Grau de Protecção **IP 54**



INDICAÇÃO DE CARGA



WATER PROOF  
**IP 54**



CÓD.		ALCANCE	ALCANCE COM RECEPTOR Ø	€
<b>61432</b>	●	30 m	50 m	<b>149,50 119,00</b>

# METRICA FLASH 360 "A LATA"

- Alcance **80 m ou 120 m** com Receptor (**não incluído**)
- Nível de laser **verde**
- Projeta um **plano horizontal 360°** e um **plano vertical 90°** formando **1 cruz na parede**
- Laser com **intensidade ajustável**
- Uso interno / externo (Pode ser utilizado com Receptor **Cód. 60749 não incluído**)
- **Base magnética e tampa metálica** para fácil **sobreposição**
- **Bateria Li-ion recarregável** e Cabo incluído (USB)
- Grau de Proteção **IP 54**



**INDICAÇÃO DE CARGA**

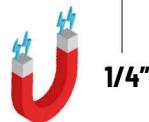

**TAMANHO DE LATA DE BEBIDA**

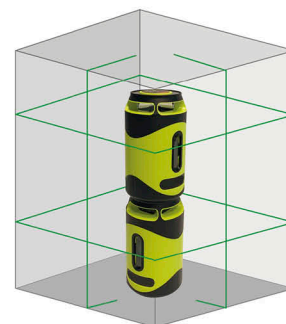

**Ex. 2 FLASHES DE 360° EMPILHADOS E RAIOS VERTICAIS AJUSTÁVEIS**

CÓD.		ALCANCE Ø *	ALCANCE COM RECEPTOR Ø*	€
<b>61435</b>		80 m	120 m	<b>184,95 149,00</b>

\* feixe horizontal

# 2025

# PROMOÇÃO

## LASER GROUND 360 GREEN

- Alcance **60 m ou 100 m** com Receptor (**não incluído**)
- Projecta um **plano horizontal de 360°** mais um **plano vertical de 90°** formando 1 cruz na parede
- Ajustes manual de intensidade do laser
- Possibilidade de bloqueio do sistema pendular
- Modo de impulsos para uso com Receptor (**não incluído**)
- Desenho compacto e robusto
- Uso interno (Pode ser utilizado com Receptor **Cód. 60749 não incluído**)
- Rosca de 1/4"
- Inclui Suporte magnético de parede, Mala e Cabo (USB-C)
- **Bateria Li-ion recarregável** (USB)
- Grau de Proteção **IP 54**

**NEW**



**ESPECIAL SOLOS**

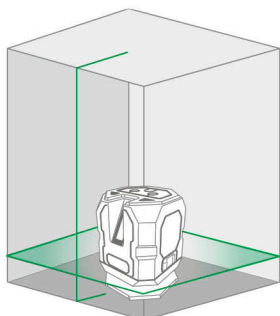

Cód. 0936

**OFERTA**

X-ATO METRICA ONE 1MM "EL MONOLITO"



**INDICAÇÃO DE CARGA**

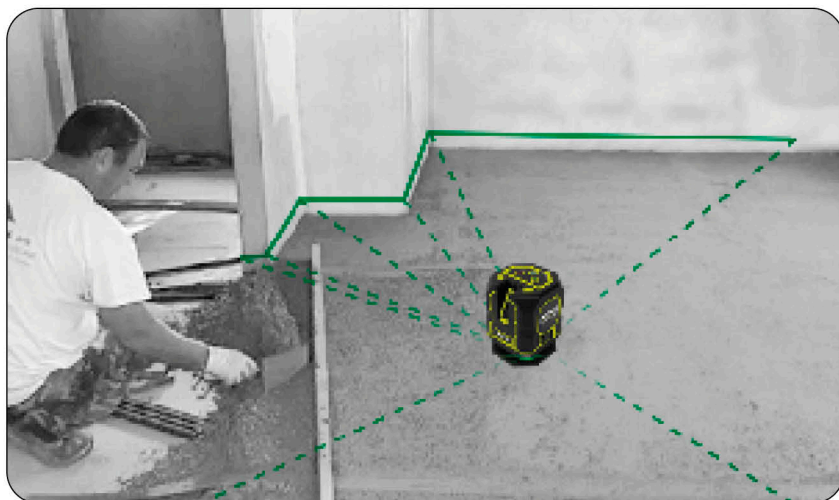

CÓD.	ALCANCE Ø*	ALCANCE COM RECEPTOR Ø*	€
<b>61425</b>	60 m	100 m	<b>204,35 169,00</b>

\* feixe horizontal

# NÍVEIS LASER METRICA 3D

- 61410MPLUS Modelo **Profissional** com alcance **60 m ou 100 m** com Receptor (**não incluído**)
- 61415MPLUS Modelo **Junior** com alcance **40 m ou 80 m** com Receptor (**não incluído**)
- Projecta **3 planos laser a 360°** e 4 quadrados nas paredes
- Inclui **Comando** para acender e apagar cada feixe laser individualmente e ajustar a intensidade do feixe
- **LED** para indicação do nível de carga da bateria
- Possibilidade de inclinações
- Janelas ópticas e linha de prumo sempre visível
- Visibilidade muito elevada (Modelo **Profissional**)
- Inclui **2x baterias de iões de lítio recarregável** até 30 horas (USB-C), Óculos de proteção e Mala robusta
- Opcional: Receptores, tripé, base deslizante
- Grau de Proteção **IP 54**



**OFERTA: SUPORTE DE PAREDE MAGNÉTICO**

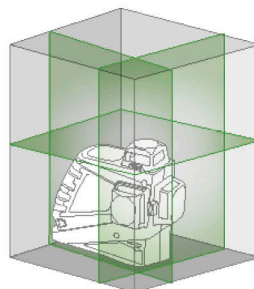
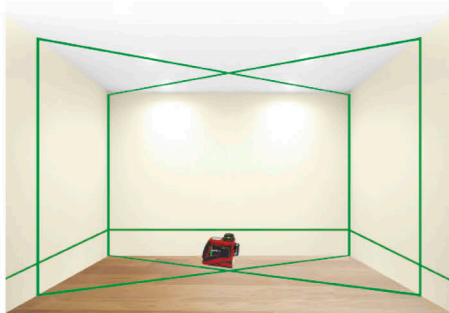

**30 HORAS**

**CONJUNTO DE 2 BATERIAS IÕES DE LÍTIO**



Cód. 0936

**OFERTA**

X-ATO METRICA ONE 1 MM "EL MONOLITO"



Suporte opcional Cód. 60560

		CÓD.	ALCANCE Ø	ALCANCE COM RECEPTOR Ø	€
Profissional	●	<b>61410MPLUS</b>	60 m	100 m	<b>598,95 484,05</b>
Junior	●	<b>61415MPLUS</b>	40 m	80 m	<b>390,35 328,80</b>

## METRICA 3D ACTION GREEN

- Alcance **60 m ou 100 m** com Receptor (**não incluído**)
- Projecta **3 feixes de laser a 360°**  
um plano horizontal e dois planos verticais
- Botões **Soft Touch**
- Inclui **Comando à distância** para acionar e ajustar a intensidade dos feixes laser
- Roscas de tripé de 1/4" e 5/8"
- Inclui **2x baterias** de íões de lítio com uma duração de **10 horas cada**, recarregáveis no interior ou no exterior do aparelho
- Inclui Suporte de parede magnético ajustável, cabo USB-C e Bolsa com espuma técnica resistente a choques
- Grau de Proteção **IP 54**

**NEW**



COMANDO À DISTÂNCIA



INDICADOR CARGA BATERIA

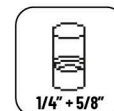
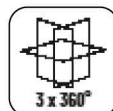

CARREGAMENTO DIRETO DAS BATERIAS VIA PORTA USB-C

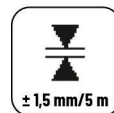

2 BATERIAS INCLUÍDAS

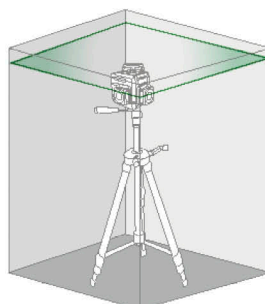
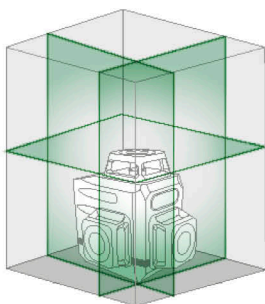

CÓD.	ALCANCE Ø*	ALCANCE COM RECEPTOR Ø*	€
61438	60 m	100 m	365,60 299,00

\* feixe horizontal

# METRICA 3D MINI GREEN

- Alcance **60 m ou 100 m** com Receptor (**não incluído**)
- Laser verde autonivelante
- Projeta **3 feixes laser 360°**  
um feixe horizontal e dois verticais formando até **3 cruzes e 2 pontos de prumo** (acima e abaixo) quadrados de 90° visíveis
- Uso interno (Pode ser utilizado com Receptor **Cód. 60749 não incluído**)
- Sistema de bloqueio automático para evitar vibrações durante o transporte
- Design compacto
- Autonivelção do Laser caso esteja fora do alcance
- Inclui **Comando à distância** para controlo dos feixes de laser e ajuste da intensidade
- Rosca de 1/4"
- Bateria de iões de lítio incorporada (autonomia de 4 a 6 h)
- Inclui Suporte de parede magnético ajustável, cabo USB e Bolsa com espuma técnica resistente a choques
- Grau de Proteção **IP 54**

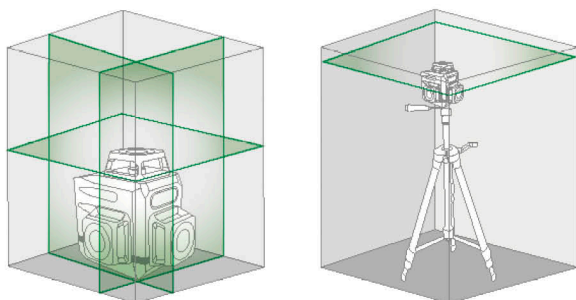
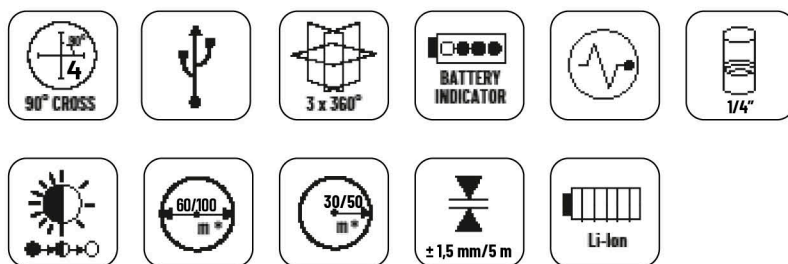

CÓD.	ALCANCE Ø*	ALCANCE COM RECEPTOR Ø*		
<b>60845</b>	60 m	100 m	<b>300,00</b>	<b>235,00</b>

# 2025

# PROMOÇÃO

## BRAVO LASER ROTATIVO H4

- Alcance **500 m** com Receptor (**incluído**)
- Nível laser vermelho **horizontal** automático com função manual de dupla inclinação
- Linha de **Prumo** laser para solo e teto
- 4 punhos de borracha para um manuseamento fácil e eficaz
- Receção do Comando à distância nos 4 lados da unidade
- Cobertura em liga metálica
- **LED indicador de carga**
- Grau de Proteção **IP 66**

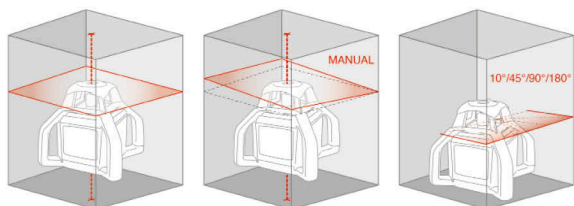

**INDICADOR LED CARGA DE BATERIA**

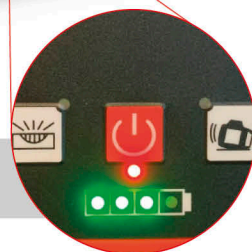

Inclui recetor 60736:

CÓD.	€
<b>61385</b>	<b>720,45</b> 547,95

Versão com recetor milimétrico 61326:

CÓD.	€
<b>89333</b>	<b>866,15</b> 666,70



## PACK LASER ROTATIVO H4



Cód. 61385



Cód. 60498



Cód. 49204  
mira 4 m



Inclui recetor 60736:

CÓD.	€
<b>89317</b>	<b>866,15</b> 629,00

Versão com recetor milimétrico 61326:

CÓD.	€
<b>89334</b>	<b>1011,85</b> 785,40



## BRAVO LASER ROTATIVO H4 GREEN

- Alcance **500 m** com Receptor (**incluído**)
- Nível laser verde **horizontal** automático com função manual de dupla inclinação
- Linha de **Prumo** laser para solo e teto
- 4 punhos de borracha para um manuseamento fácil e eficaz
- Receção do Comando à distância nos 4 lados da unidade
- **Corpo amarelo FLASH** para maior visibilidade em estaleiros de construção
- Inclui Bateria Li-ion recarregável
- Cobertura em liga metálica
- **LED indicador de carga**
- Grau de Proteção **IP 66**

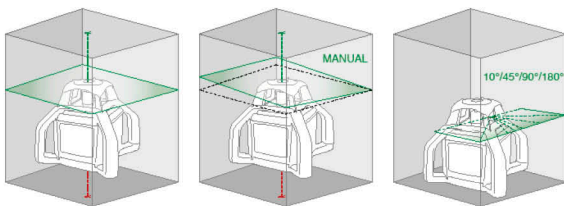

**INDICADOR LED  
CARGA DE BATERIA**



Inclui recetor 60724:

CÓD.	€	€
61386	806,50	621,05



**COMANDO  
À DISTÂNCIA**



Versão com recetor milimétrico 61393:

CÓD.	€	€
89320	952,20	726,95



**OFERTA**

## PACK LASER ROTATIVO H4 GREEN



Cód. 61386



**OFERTA**



Cód. 60498



Cód. 49204  
mira 4 m



Inclui recetor 60724:



CÓD.	€	€
89322	952,20	726,95

Versão com recetor milimétrico 61393:



CÓD.	€	€
89321	1097,85	831,10



## BRAVO LASER ROTATIVO HV4

- Alcance **500 m** com Receptor (**incluído**)
- Nível laser Vermelho horizontal e vertical
- Dupla inclinação manual
- Função de TILT e escaner em 4 cantos
- Cobertura em liga metálica
- Inclui Lente, olhos de proteção, bateria extra e Carregador
- Grau de Proteção **IP 66**



500 m  
 3mm/30m  
 TILT  
  
 60 - 120 / 300 - 600 rpm  
 NI-MH

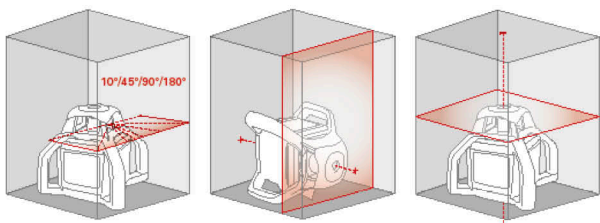

**EM MALA ROBUSTA**

220 V



**OFERTA**

CÓD.	€	
61350	1183,90	895,00

## PACK PRO - BRAVO LASER ROTATIVO HV4



Cód. 61350

Cód. 60581



Cód. 60621

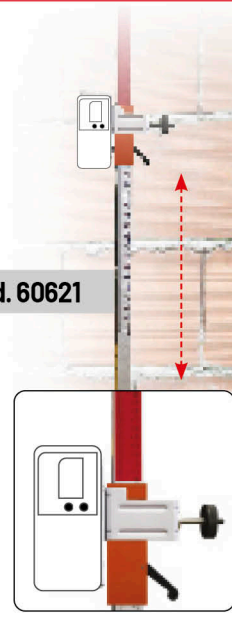

MIRA 2 M 40



**OFERTA**



220 V

CÓD.	€	
89293	1440,90	1114,20

## BRAVO LASER ROTATIVO HV4 GREEN

- Alcance **500 m** com Receptor (incluído)
- Nível laser **verde** de alta visibilidade
- Pontos de prumo Vermelho (em baixo) e Verde (em cima)
- Dupla inclinação manual
- Rotação horizontal ou vertical
- Função de TILT e escaner em 4 cantos
- Recetor de 4 sectores e Comando à distância incluídos
- Cobertura em liga metálica
- Inclui **Bateria de iões de lítio**, Lente, óculos de proteção e Carregador
- Grau de Proteção **IP 66**



COMANDO À DISTÂNCIA

500 m	3mm/30m	TILT		60 - 120 300 - 600 rpm	Li-Ion
-------	---------	------	--	---------------------------	--------

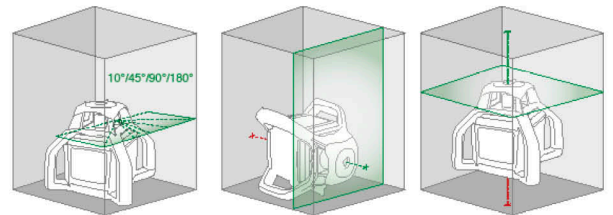

CÓD.	€	
61395	1344,10	984,50

## PACK - BRAVO LASER ROTATIVO HV4 GREEN



Cód. 60581



Cód. 60621

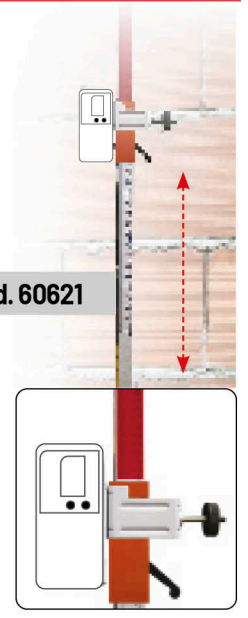

MIRA 2 M 40

Cód. 61395



CÓD.	€	
89324	1601,10	1203,70

# 2025

# PROMOÇÃO

## BRAVO LASER ROTATIVO INCLIGRAD 2

- Alcance **500 m** com Receptor (incluído)
- **Recetor com indicador milimétrico**
- Laser Digital de construção com **dupla inclinação +/- 10%**
- Função de TILT e escaner em 4 cantos
- Cobertura em liga metálica
- Ideal para trabalhos de paisagismo, terraplanagem, agricultura, parques e jardins
- Precisão **1 mm em cada 10 metros**
- Grau de Proteção **IP 54**



INDICAÇÃO MILIMÉTRICA

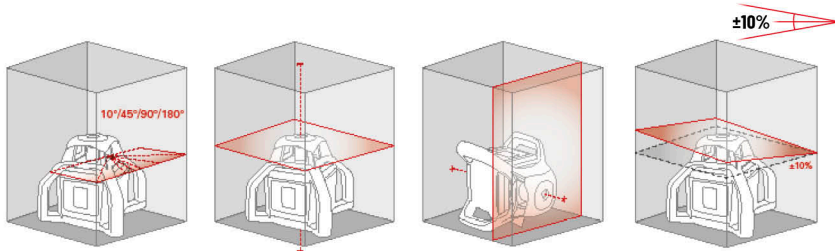

CÓD.		€
61345	220 x 220 x 210 mm	1814,00 1278,55



OFERTA

EM MALA ROBUSTA

220 V

## PACK PRO - BRAVO LASER ROTATIVO INCLIGRAD 2



Cód. 60581

Cód. 60621



Cód. 61345

CÓD.	€
89316	2071,00 1497,75



EM MALA ROBUSTA

220 V

MIRA 2 M 40



## BRAVO LASER ROTATIVO INCLIGRAD 2 GREEN

- Alcance **500 m** com Receptor (incluído)
- **Recetor com indicador milimétrico**
- Laser Digital de construção com **dupla inclinação +/- 10%**
- Função de TILT e escaner em 4 cantos
- Cobertura em liga metálica
- Ideal para trabalhos de paisagismo, terraplanagem, agricultura, parques e jardins
- Precisão **1 mm em cada 10 metros**
- Grau de Proteção **IP 54**

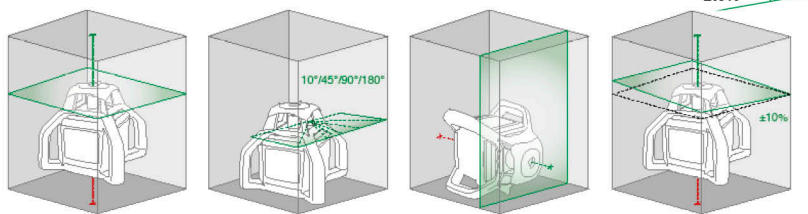

CÓD.		€	
61392	220 x 220 x 210 mm	1989,25	1406,40

## PACK - BRAVO LASER ROTATIVO INCLIGRAD 2 GREEN

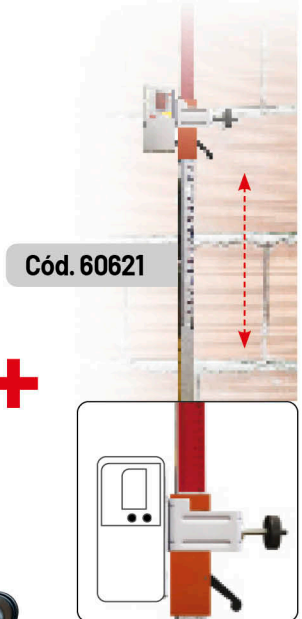

CÓD.		€
89323		2089,00 1327,60



# 2025

# PROMOÇÃO

## BRAVO LASER ROTATIVO H2 RED

- Alcance **500 m** com Receptor (**incluído**)
- Construção sólida
- Nível laser Vermelho autonivelante
- Prumo laser de solo e teto
- Indicador de carga LED
- Inclui **Bateria Li-ion recarregável** com porta (USB-C), Carregador, Lente, Óculos de proteção, Comando à distância, Receptor e Suporte
- Grau de Proteção **IP 65**

**NEW**



**WATER PROOF**  
**IP 65**

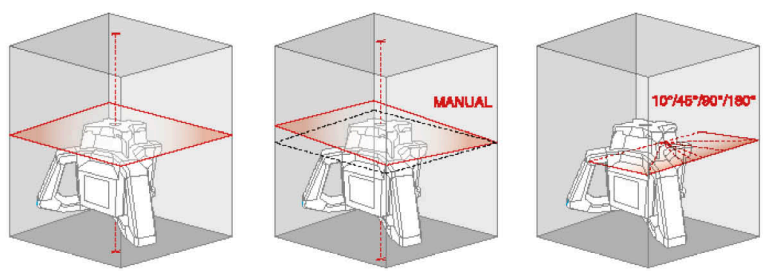

CÓD.	€	
61700	655,95	447,50

## PACK BRAVO LASER ROTATIVO H2 RED



Cód. 61700

+



Cód. 60498

+



Cód. 49204  
mira 4 m

**WATER PROOF**  
**IP 65**



CÓD.	€	
89700	801,10	547,95

**NEW**

# PACK RECEPTOR DE CONTROLO DE MÁQUINAS MAGNÉTICO + PINÇAS

- Permite o controlo do nivelamento do terreno com a máquina de terraplanagem
- Interceta o sinal de **qualquer laser giratório com feixes vermelhos e verdes**
- Comprimento da barra receptora (25 cm) e **recepção do sinal 360°**
- Díodos luminescentes intercetam o feixe laser
- Dupla opção de ajuste de precisão
- Receptor Remoto equipado com carregador de 220 V, cabo 12 V de ligação à bateria do veículo, e cabo de ligação entre o receptor e o receptor remoto.
- Novo pack completo com abraçadeiras, imans e ferramenta para substituição entre os dois sistemas
- Duração da bateria **± 40 horas**
- Grau de Proteção **IP 66**



**PARA LASER ROTATIVO VERMELHO E VERDE**



**MONITOR DE CABINE**



**ABRAÇADEIRAS Cód. 60871**

**IMANS Cód. 60872**



CÓD.	€
60895	1602,20 1333,35

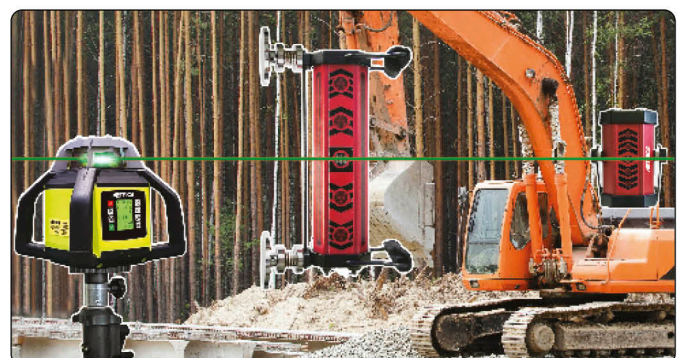

## RECETOR PROFISSIONAL COM LEITURA EM MM

- Novo Modelo universal compatível com todos os nossos lasers rotativos de feixes verdes ou vermelhos
- Alcance **350 m**
- Precisão **±1 mm** (±2 em modo normal e ±5 em modo "baixo")
- Campo de deteção muito amplo: 130 mm, indicador milimétrico a mais de 100 mm. (± 50 mm)
- Equipado com imans muito potentes na parte lateral e superior do aparelho



CÓD.		€
61701	● ●	343,05 283,15

## RECETOR PROFISSIONAL COM LEITURA EM MM

- Precisão **±1 mm**
- **Cód. 61326** compatível com os nossos lasers rotativos vermelhos (60719, 61345, 61350, 61355, 61385)
- **Cód. 61393** compatível com os nossos lasers rotativos verdes (61352, 61386, 61392, 61395)
- Sensibilidade de 4 linhas com leitura em mm/polegadas
- Visualização da diferença entre o laser e o ponto zero (em mm)



CÓD. 61326



CÓD. 61393

CÓD.		€
61326	●	343,05 265,00
61393	●	343,05 265,00

## RECETOR EXTERIOR PARA LASERS DE PÊNDULO

- Capacidade de **50 m**
- **Cód. 60748** compatível com o Código 61360, 61370, 61400M, 61405M, 60805 e 60814BR
- **Cód. 60749** compatível com o Código 60845, 61302, 61365, 61375, 61380, 61410M, 61415M, 61432, 61435 e 61438



CÓD.		€
60748	●	121,55 95,00
60749	●	137,65 95,00

## MIRA TELESCÓPICA

- Secção hexagonal robusta
- Com Bolha esférica
- Cód. 49207 graduação com "0" na parte inferior
- Em estojo



FRENTE MM VERSO GEODÉSICO



CÓD.		€
49204	4 m	55,95 38,00
49205	5 m	67,25 47,00
49207	7 m	83,90 63,95

## MIRA TELESCÓPICA

- Com Bolha esférica
- Em perfil de Alumínio anodizado
- Em estojo

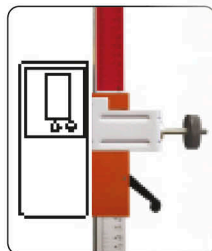

FRENTE MM VERSO GEODÉSICO



CÓD.		€
60621	2,4 m	89,25 63,95

## TRIPÉ TELESCÓPICO

- Suporte ajustável com tripé
- Para lasers de cruz e de linha
- Em estojo

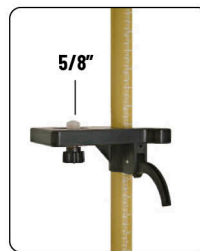

5/8"

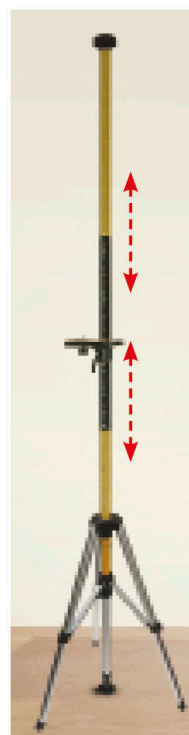

CÓD.		€
60560	3,6 m	116,15 98,65

## TRIPÉ DE ELEVAÇÃO

- Robusto
- Indicador de nível por bolha
- Ajuste da altura com graduação
- Tripé com punções ou protecção de borracha

5/8"



CÓD.		€	
60581	95 ÷ 195 cm	167,75	142,50
60582	112 ÷ 335 cm	198,95	167,00

## TRIPÉ DE ALUMÍNIO

- Barra telescópica
- **Altura elevada**
- Elevação por cremalheira
- Amplitude de trabalho 90 ÷ 290 cm
- Bolsa de transporte

5/8"



CÓD.		€	
60586	90 ÷ 290 cm	164,00	146,15

## TRIPÉ DE ALUMÍNIO

- Muito estável e sólido
- Indicador de nível por bolha
- Elevação por cremalheira
- Amplitude de trabalho 63 ÷ 182 cm
- Bolsa de transporte

5/8"



CÓD.		€	
60585	63 ÷ 182 cm	90,90	74,00

## TRIPÉ LIGEIRO

- Muito leve
- Cabeça giratória e removível
- Amplitude de trabalho 55 ÷ 150 cm
- Bolsa de transporte

1/4"



CÓD.		€	
60590		39,80	37,05

## PACK NÍVEL ÓPTICO 32X

- Alcance **1000 m**
- Zoom **32 x**
- Mira telescópica **4 m**
- Amortecimento magnético
- Tripé 1,59 M
- Grau de Proteção **IP 54**



Cód. 60466



Cód. 60498



Cód. 49204



cód.		€
89222	ZOOM 32X	403,80 274,00

## TRIPÉ "ALL BLACK"



- Aço leve e fácil de transportar
- Cabeça basculante
- Amplitude de trabalho 53 ÷ 150 cm
- Cremalheira para um ajuste fácil a 27 cm
- Rosca 1/4" para fixação de lasers
- 2 bolhas para uma maior precisão
- Pés articulados de borracha para uma perfeita adaptação ao solo
- Bolsa de transporte



cód.	€
60599	27,45 23,75

## TRIPÉ ALU

- Base plana
- Para níveis ópticos
- Sistema "quick lock"
- Rosca 5/8" para fixação de lasers
- Amplitude de trabalho 97 ÷ 159 cm
- Bolsa de transporte



cód.	€
60498	89,80 69,45
60498D	89,80 69,45

## TERMOANEMÓMETRO

- Medição da temperatura e da velocidade do ar
- Velocidade do ar: m/s, pés/min, km/h, nós e MPH (4 nós)
- Medição da temperatura em °C e °F
- Função de bloqueio do valor medido e do valor máximo (HOLD)
- Indicação de bateria
- Modo Stand-by Automático
- Inclui bateria de 9V.
- Inclui Bolsa

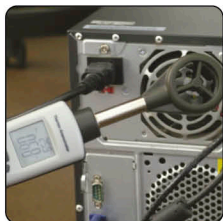

CÓD.		€	€
60291	255 x 62 x 30 mm	150,00	105,95

## DETETOR DIGITAL

- **Detetor de metais, madeira e cabos eléctricos**
- Indicador da profundidade de deteção até:
  - 8 cm para o metais
  - 2 cm para madeira
  - 5 cm para os cabos eléctricos de baixa tensão
- Indicação da profundidade no ponto central
- Calibração automática
- Ecrã retroiluminado
- Inclui Bolsa



METAIS



MADEIRA



FERRO



FIOS ELÉCTRICOS

CÓD.	€	€
61532	120,45	73,10

## ESCLERÓMETRO

- Medição da resistência do betão
- Demarcação de áreas danificadas
- Ensaio não destrutivo
- Resultado da leitura em kg/cm<sup>2</sup>
- Em caixa

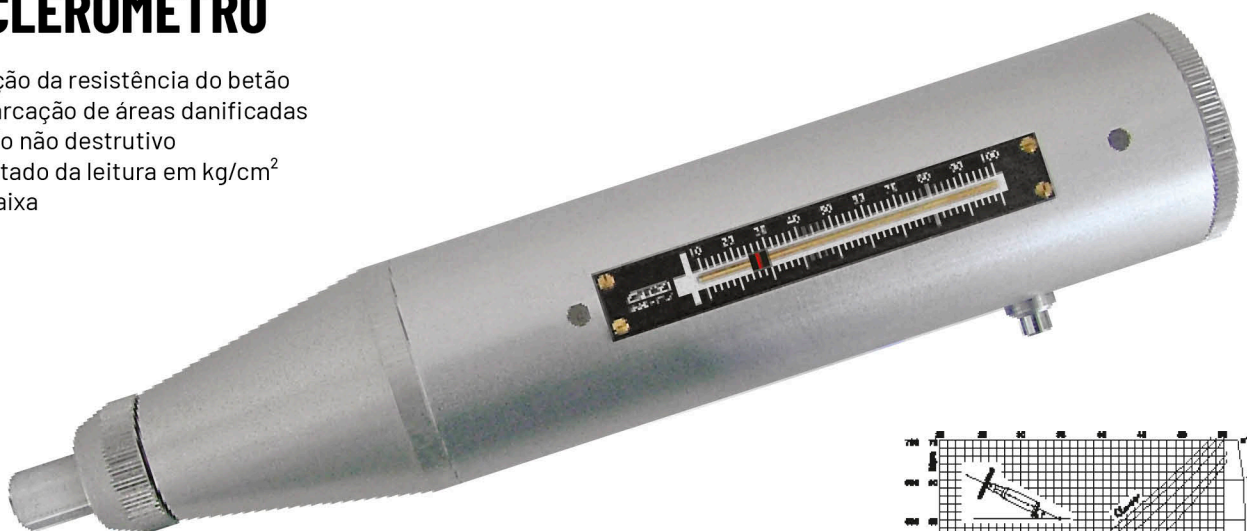

CÓD.	€	€
60210	486,05	401,85

Gama de medição  
100 a 700 kg/cm<sup>2</sup>

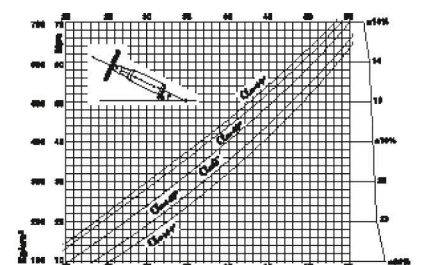

## MEDIDOR DE ÂNGULO DIGITAL MINI INCLIGRAD

- Ecrã LCD retroiluminado com dígitos grandes
- Rotação automática de 180° do ecrã e setas para ajudar a encontrar o ponto "0"
- Mede 4 x 90° com precisão  $\pm 0,2^\circ$
- Função de medição absoluta
- Valor de medição em graus ( $^\circ$ ) e percentagens (%)
- Equipado com **ímans nos 4 lados**
- Bateria **recarregável com íões de lítio** (USB-C)



ROTAÇÃO DE ECRÃ

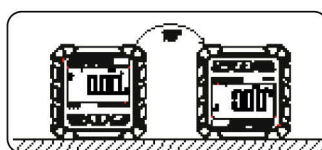

ÍMANS NOS 4 LADOS

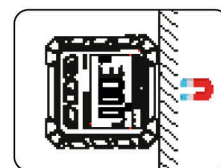

cód.	62x62x32 mm	1	€
<b>60295</b>			<b>63,45 53,00</b>

## NÍVEL DIGITAL INCLIGRAD

- Ecrã iluminado
- Leitura digital de graus ( $^\circ$ ) e percentagens (%)
- Botão de bloqueio
- Sinal acústico 0° e 90°

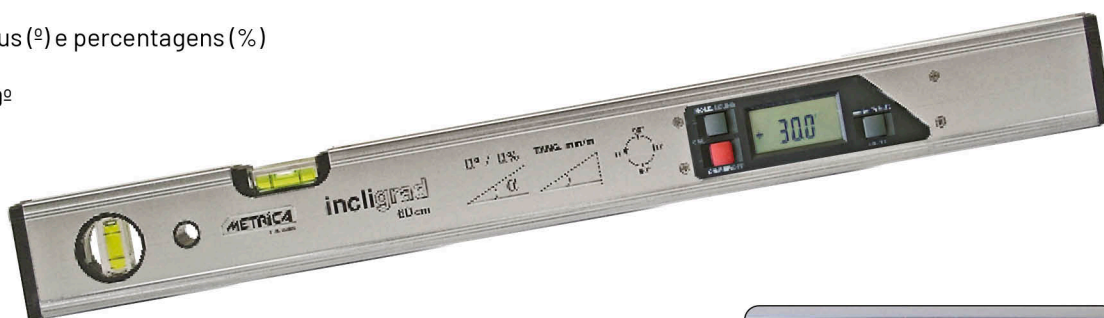

cód.		1	€
<b>33806</b>	60 cm		<b>115,10 88,00</b>
<b>33810</b>	100 cm		<b>132,80 115,10</b>

## MEDIDOR DE ÂNGULO DIGITAL

- Ecrã iluminado
- Leitura digital 0,05°
- Botão de bloqueio
- 0° - 225°



cód.		1	€
<b>29890</b>	50 cm		<b>191,40 142,50</b>

# quadranfix

MADE IN ITALY

- Goniómetro
- Modelo mais robusto e preciso
- Braço com parafuso de bloqueio
- 0° - 180°

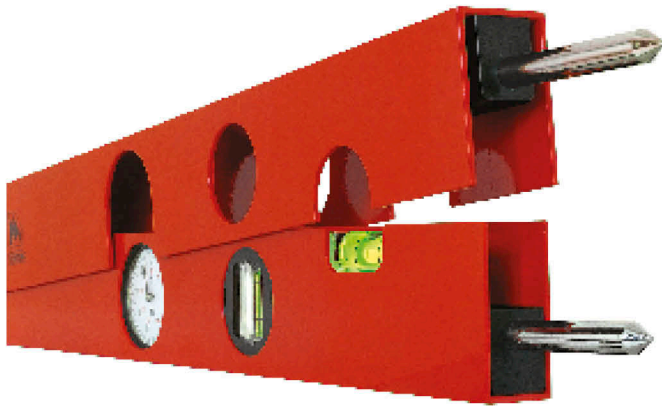

2 BOLHAS DE ACRÍLICO



QUADRANTE:  
0°-90°  
E 90°-180°



PARAFUSO DE BLOQUEIO

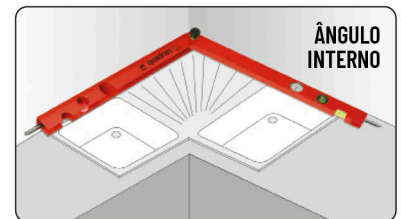

CÓD.		€	
29900	45 cm	453,80	295,90
29901	60 cm	471,00	306,85
29903	75 cm	511,85	328,80
29902	100 cm	547,35	356,20
29904	150 cm	657,00	420,10

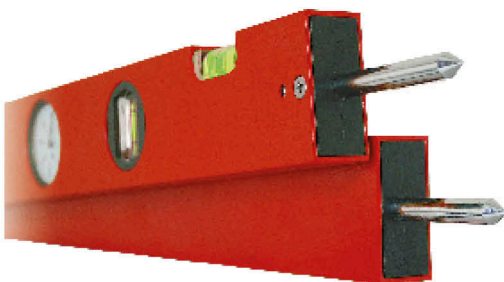

- Goniómetro
- Braços lado a lado
- 0° - 355°



CÓD.		€	
29905	60 cm	484,95	310,55

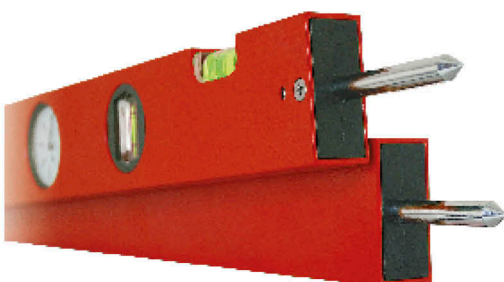

- Goniómetro
- Braço lateral **com iman**
- 0° - 355°

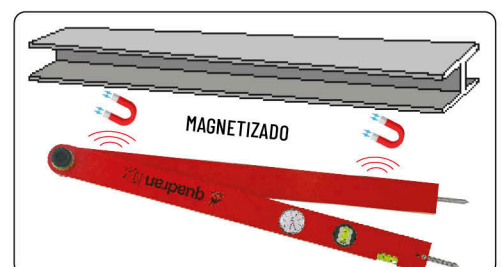
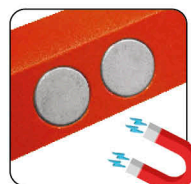

CÓD.		€	
29915	60 cm	543,05	348,90

# 2025

# PROMOÇÃO

## telefix



- Metro telescópico
- Caixa com 2 bolhas
- **Muito robusto e preciso**
- Caixa de leitura à altura do homem
- Inclui estojo de transporte



CÓD.		€	
49358	32 - 100 cm	393,55	264,85
49359	49 - 200 cm	406,50	274,00
49360	66 - 300 cm	428,00	290,45
49361	83 - 400 cm	463,45	314,20
49362	99 - 500 cm	569,90	383,60
49363	116 - 600 cm	672,05	438,40
49365	135 - 800 cm	840,90	575,35
49366	163 - 1000 cm	988,20	677,65



**BASE COM CAPA IMPERMEÁVEL (PATENTEADO)**

## TELEFIX PARA JANELAS

- Metro telescópico
- Caixa de leitura especial para instaladores de janelas e portas
- Inclui estojo de transporte



CÓD.		€	
49364	66 - 300 cm	437,65	297,75



CÓD.	
EXPO TELEFIX	65 x 150 x 30 cm

# telefix<sup>®</sup> PLUS

MADE IN ITALY

- Mais robusto, mais rígido, melhor visibilidade
- Utilização com braço telescópico e acessórios (não incluídos)

CE III

MAIS ROBUSTA

telefix telefix PLUS

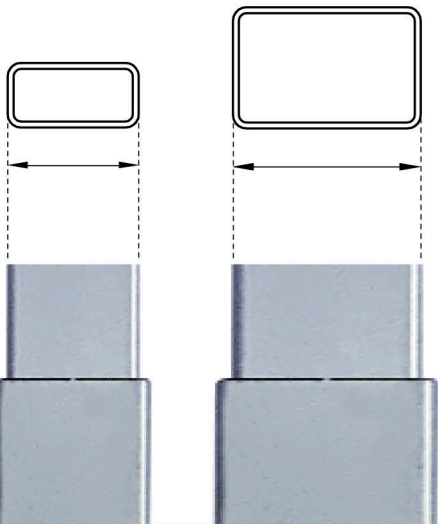

MAIS RÍGIDO

## TELEFIX PLUS

cód.	L		€	
49347	5 m	118 - 500 cm	605,40	392,70
49348	6 m	138 - 600 cm	709,70	456,65
49349	8 m	153 - 800 cm	914,00	584,50

## TELEFIX PLUS COM BRAÇO TELESCÓPICO

cód.	L		€	
49367	5 m	118 - 500 cm	897,85	575,35
49368	6 m	138 - 600 cm	1000,00	639,30
49369	8 m	153 - 800 cm	1204,35	767,15

## BRAÇO TELESCÓPICO

cód.		€	
49344	100 - 200 cm	300,00	182,65



NOVA FITA DE LEITURA VERTICAL

**BRAÇO TELESCÓPICO 1 m ÷ 2 m \***  
(Cód. 49344 Opcional)

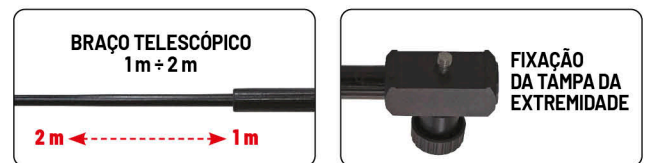

\* Patenteado  
O uso de acessórios invalida automaticamente a Certificação CE

## NÍVEL DE TRAPÉZIO EM ALUMÍNIO

- Muito robusto com grande resistência
- Construção em Alumínio fundido maciço
- Bolhas acrílicas
- Base fresada



BASE MAGNÉTICA

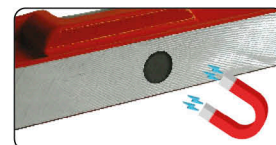

cód.			€	
31072	25 cm	6	28,75	18,65
31073	30 cm	6	28,65	19,20
31074	40 cm	6	31,75	21,05
31075	50 cm	6	35,70	23,60
31076	60 cm	6	39,05	26,50
31078	80 cm	3	68,30	45,50
31080	100 cm	3	90,35	60,30

cód.				€	
31062	U	25 cm	6	40,90	26,50
31063	U	30 cm	6	41,40	27,40
31064	U	40 cm	6	42,30	28,35
31065	U	50 cm	6	51,20	34,75
31066	U	60 cm	3	55,50	37,55

## MINI NÍVEL "ALL BLACK" COM IMAN

- Modelo de bolso
- Iman invisível, dentro do perfil
- Bolha acrílica horizontal
- Tampas de borracha anti-choque
- Perfil de Alumínio 10 cm



cód.		€	
31027	12	16,15	9,90

## MINI NÍVEL "ALL BLACK"

- Duas bolhas de acrílico resistentes ao impacto
- Tampas de borracha anti-choque
- Perfil de Alumínio 20 cm
- Cód. 31029 magnético (com iman invisível)

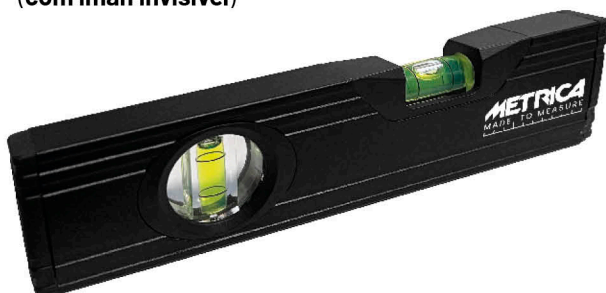

cód.			€	
31028		1	22,60	14,45
31029	U	1	30,15	19,55

## MINI NÍVEL TRANSPARENTE 360º

- Modelo de bolso
- 2 Bolhas de resina resistente ao impacto
- Secção retangular 100 x 51 mm

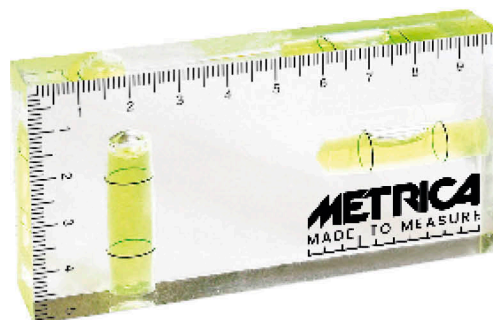

cód.		€	
33036	1	21,30	12,50

## METRICA **FLASH XL**

- Precisão **0,3 mm/m**
- Duas bases fresadas (até 120 cm)
- Tampas de borracha anti-choque
- Secção retangular 60 x 24 mm

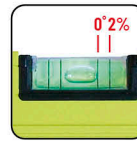
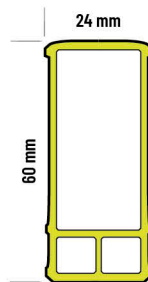
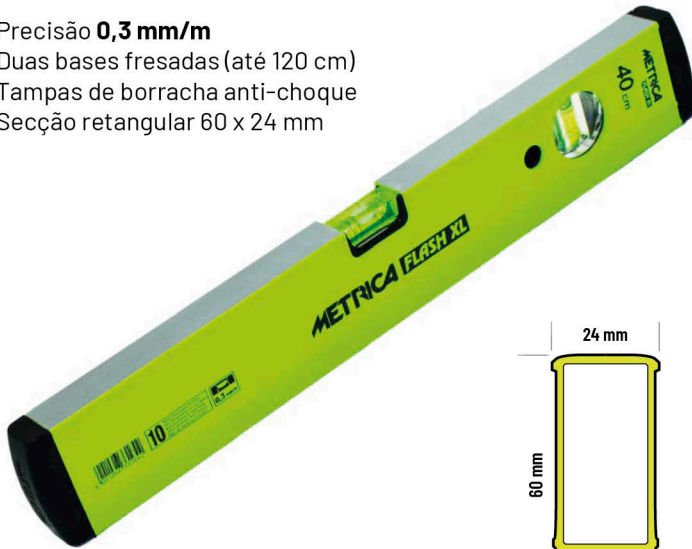

TAMPAS DE BORRACHA

CÓD.			€	
33164	40 cm	3	42,30	27,40
33165	50 cm	3	48,65	31,50
33166	60 cm	3	53,70	34,90
33168	80 cm	1	61,85	39,95
33170	100 cm	1	68,30	44,20
33172	120 cm	1	80,15	52,00
33175	150 cm	1	86,60	56,00
33178	180 cm	1	95,70	63,00
33180	200 cm	1	108,65	69,45

## RÉGUA DE NÍVEL EM ALUMÍNIO

- 2 pegas
- 2 bolhas acrílicas
- Secção retangular 100 x 18 mm

CÓD.			€	
32271	150 cm	5	41,55	29,00
32272	180 cm	5	48,95	35,10
32273	200 cm	5	53,70	38,00
32274	250 cm	5	66,70	46,80
32275	300 cm	5	73,15	52,00

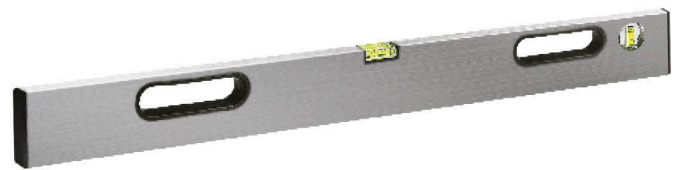

## SUTA GRADUADA

- Régua em **aço graduada 240 mm**
- Base de Madeira com fixação por porca orelhas
- A 150 mm x B 250 mm

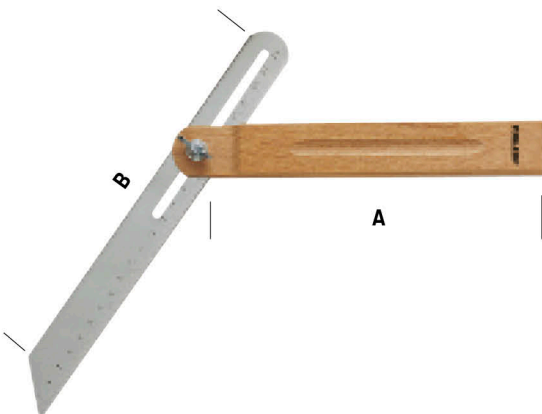

CÓD.		€	
69650	5	13,25	9,00

## ESQUADRO CARPINTEIRO

- Aço lacado

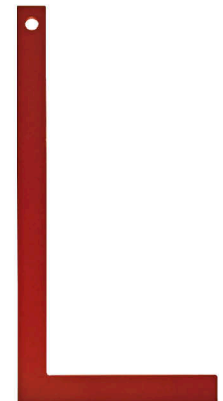

CÓD.			€	
29354	400 mm	5	13,80	9,80
29355	500 mm	5	14,80	10,70
29356	600 mm	5	16,60	11,75
29357	700 mm	5	18,10	12,80
29358	800 mm	5	19,70	13,50
29359	1000 mm	5	22,00	14,65

# 2025

# PROMOÇÃO

## FLASH

- Nível com 2 bolhas
- Corpo fluorescente
- Precisão **0,5 mm/m**
- Secção retangular 48 x 22 mm



CÓD.			€	
<b>33130</b>	30 cm	3	<b>25,40</b>	<b>16,45</b>
<b>33134</b>	40 cm	3	<b>26,80</b>	<b>17,40</b>
<b>33135</b>	50 cm	3	<b>30,65</b>	<b>19,95</b>
<b>33136</b>	60 cm	3	<b>33,70</b>	<b>21,95</b>
<b>33138</b>	80 cm	1	<b>40,15</b>	<b>25,60</b>
<b>33140</b>	100 cm	1	<b>46,35</b>	<b>28,35</b>
<b>33141</b>	120 cm	1	<b>54,35</b>	<b>33,65</b>
<b>33142</b>	150 cm	1	<b>59,70</b>	<b>37,45</b>
<b>33145</b>	180 cm	1	<b>66,70</b>	<b>42,65</b>
<b>33150</b>	200 cm	1	<b>78,00</b>	<b>47,50</b>

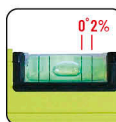
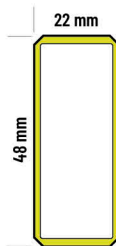

TAMPAS DE BORRACHA

## EXPOSITOR PARA NÍVEIS

### EXPOSITOR FLASH C/ 30 NÍVEIS

CÓD.			
<b>98080</b>	<b>33134</b>	40 cm	6
	<b>33135</b>	50 cm	6
	<b>33136</b>	60 cm	6
	<b>33138</b>	80 cm	6
	<b>33140</b>	100 cm	6
		<b>679,50</b>	

€



## FLASH XL

- Nível XL com 2 bolhas
- Corpo fluorescente
- Precisão **0,3 mm/m**
- Secção retangular 60 x 24 mm



CÓD.			€	
<b>33185</b>	50 cm	1	<b>57,55</b>	<b>36,55</b>
<b>33186</b>	60 cm	1	<b>61,30</b>	<b>38,40</b>
<b>33182</b>	80 cm	1	<b>72,05</b>	<b>45,30</b>
<b>33183</b>	100 cm	1	<b>80,15</b>	<b>49,90</b>

CÓD.			€	
<b>33212</b>	120 cm	1	<b>104,35</b>	<b>65,80</b>
<b>33215</b>	150 cm	1	<b>111,85</b>	<b>71,25</b>
<b>33218</b>	180 cm	1	<b>124,75</b>	<b>80,40</b>
<b>33220</b>	200 cm	1	<b>144,10</b>	<b>89,50</b>

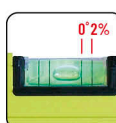
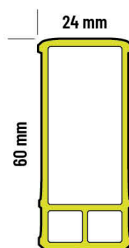

TAMPAS DE BORRACHA

## EXPOSITOR PARA NÍVEIS

### EXPOSITOR FLASH XL C/ 30 NÍVEIS

CÓD.			
<b>98082</b>	<b>33185</b>	50 cm	6
	<b>33186</b>	60 cm	6
	<b>33182</b>	80 cm	6
	<b>33183</b>	100 cm	6
	<b>33212</b>	120 cm	2
	<b>33218</b>	180 cm	2
	<b>33220</b>	200 cm	2
		<b>1492,30</b>	

€



## megalevel **IN**VISIBLE

- Nível com 2 bolhas
- Corpo fluorescente
- **Ímãs fortes e invisíveis** incorporados na base
- Precisão **0,5 mm/m**
- Secção retangular 50 x 22 mm

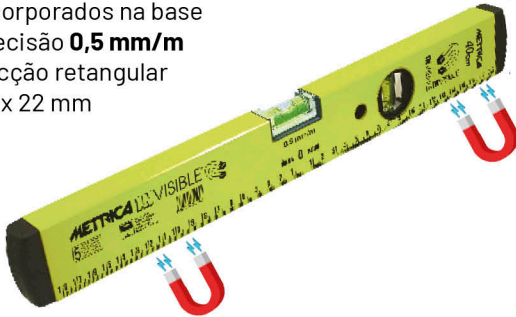

CÓD.	●	☐	📦	€	
32224	40 cm	3		44,85	29,25
32225	50 cm	3		53,45	33,80
32226	60 cm	3		58,65	38,00
32228	80 cm	1		65,60	42,60
32230	100 cm	1		73,15	46,05
32232	120 cm	1		82,30	53,00
32365	150 cm	1		89,80	58,45
32368	180 cm	1		102,20	66,50
32370	200 cm	1		115,60	75,25

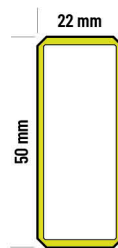

TAMPAS DE BORRACHA

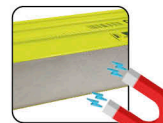

ÍMAN INVISÍVEL

## EXPOSITOR PARA NÍVEIS

### EXPOSITOR MEGALEVEL INVISÍVEL C/ 30 NÍVEIS

CÓD.				📦
98081	32224	U	40 cm	6
	32225	U	50 cm	6
	32226	U	60 cm	6
	32228	U	80 cm	6
	32230	U	100 cm	2
	32365	U	150 cm	2
	32370	U	200 cm	2
<b>1221,40</b>				

€



## formula **IN**VISIBLE

- Nível com 2 bolhas
- Corpo fluorescente
- **Ímãs fortes e invisíveis** incorporados na base
- Precisão **0,5 mm/m**
- Secção retangular 62 x 25 mm

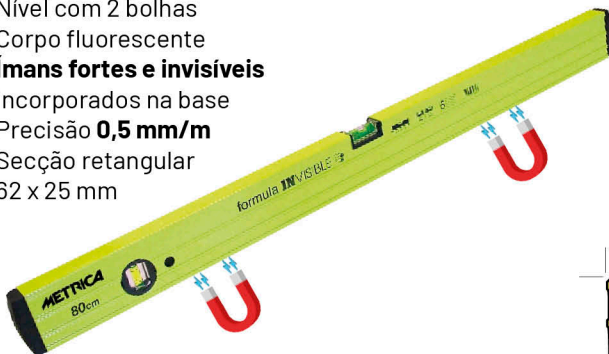

CÓD.	●	☐	📦	€	
32834	40 cm	3		55,40	35,35
32835	50 cm	3		67,25	42,95
32836	60 cm	3		71,55	45,70
32838	80 cm	1		79,05	49,35
32840	100 cm	1		86,05	56,30
32842	120 cm	1		116,70	69,00
32837	150 cm	1		131,75	79,50
32839	180 cm	1		145,20	85,00
32841	200 cm	1		159,15	95,00

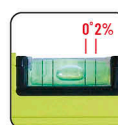

TAMPAS DE BORRACHA

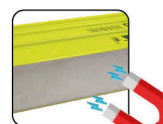

ÍMAN INVISÍVEL

## EXPOSITOR PARA NÍVEIS

### EXPOSITOR FÓRMULA INVISÍVEL C/ 30 NÍVEIS

CÓD.				📦
98083	32834	U	40 cm	6
	32835	U	50 cm	6
	32836	U	60 cm	6
	32838	U	80 cm	3
	32840	U	100 cm	3
	32842	U	120 cm	2
	32837	U	150 cm	2
	32841	U	200 cm	2
<b>1547,95</b>				

€



# 2025

# PROMOÇÃO

## METRICA **BLACK BULL** CE II

- **Dupla graduação**
- Rigidez horizontal de **4 m**
- Fita de aço com textura e revestimento em **Nylon** resistente à abrasão
- **Gancho duplo** de maior dimensão para melhor aderência
- Ímã que mede o "0" da graduação

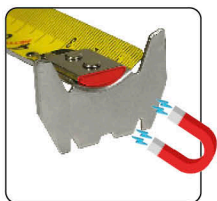

CÓD.	5 m	32 mm	6	€	€
08075	5 m	32 mm	6	42,95	20,90
08078	8 m	32 mm	6	56,50	28,50

## METRICA "ALL BLACK" CE II

- **Dupla graduação**
- Rigidez horizontal de **+2,5 m**
- Espessura da fita incrementada de 40%
- Superfície de fita texturizada anti-corrosão
- Revestimento mais espesso em **Nylon**
- Fita preta e figuras brancas de maior dimensão para uma fácil leitura
- Fita com **Sistema Autobloqueio**



ACABAMENTO TEXTURIZADO  
ALTA PROTEÇÃO  
DURAÇÃO DA ABRASÃO  
10 VEZES MAIOR

**ZOOM  
10X**

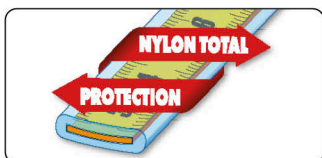
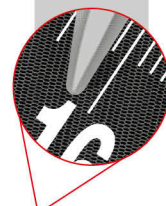

**EXPOSITOR CARROSSEL  
"ALL BLACK"**



CÓD.	3 m	19 mm	12	€	€
38143D	3 m	19 mm	12	18,90	8,20
38145D	5 m	25 mm	6	36,25	13,15
38148D	8 m	25 mm	6	47,00	21,95

CÓD.	38143D	3 m	12
	38145D	5 m	24
	38148D	8 m	12
	<b>677,40</b>		

€

## METRICA WING SHAPE

- **Dupla graduação**
- Numeração horizontal na frente com casas decimais amarelas
- Numeração vertical branca no verso com casas decimais vermelhas
- **Forma especial em W** (forma de asa)
- Rigidez horizontal de **+3,5 m**
- Fita revestida a Nylon **com cobertura extra nos primeiros centímetros para maior proteção**
- Fita com **Sistema Autobloqueio**
- Corpo ABS revestido em borracha resistente aos choques
- Gancho de grande dimensão

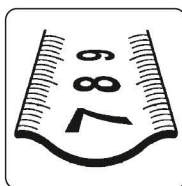
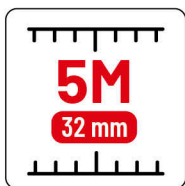
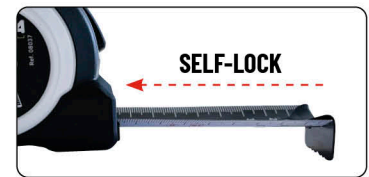

EXPOSITOR CARROSEL  
WING SHAPE



cód.				€	
08037	5 m	32 mm	6	36,25	15,10
08038	8 m	32 mm	6	48,30	20,45

cód.			
98069	08037	5 m	24
	08038	8 m	12
<b>607,80</b>			

€

## METRICA FLASH

- **Dupla graduação**
- Fita com efeito fluorescente (**frontal**)
- Corpo cromado revestido em borracha
- Alta visibilidade
- Fita de aço com textura e revestimento em **Nylon** resistente à abrasão
- Design ergonómico



SUPERFÍCIE TEXTURIZADA  
RESISTÊNCIA SUPERIOR  
À ABRASÃO

cód.				€	
08973	3 m	16 mm	6	18,95	7,90
08974	5 m	19 mm	6	27,00	11,90
08975	5 m	25 mm	6	30,45	14,90
08978	8 m	25 mm	6	41,30	19,40

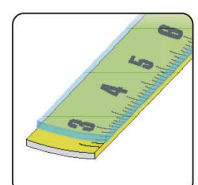

# 2025

# PROMOÇÃO

## METRICA BICOLOR

CE II



- Fita patenteada com mudança de cor a cada 10 cm para uma visibilidade instantânea e fácil até 2 m
- Maior largura da fita para maior estabilidade até 3 m horizontalmente (Cód. 08222 e Cód. 08223)
- Numeração visível e ampliada
- Corpo ABS revestido em borracha resistente aos choques - amarelo fluorescente

FITA PATENTEADA

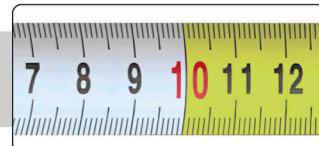

EXPOSITOR CARROSSEL BICOLOR



cód.				€	
08220	3 m	19 mm	12	12,70	6,50
08221	5 m	22 mm	12	18,00	8,65
08222	5 m	28 mm	6	20,65	10,80
08223	8 m	28 mm	6	30,15	15,10

cód.				€	
98068	08220	3 m	24		
	08221	5 m	12		
	08222	5 m	24		
	08223	8 m	6		
				609,60	

## METRICA FLASH REVERXO

CE II

- Fita com Sistema Autobloqueio em todas as posições e 1 botão de bloqueio/desbloqueio permanente
- Corpo ABS revestido em borracha resistente aos choques



RELEASE

PERMANENT STOP



GANCHO DUPLA



NÚMEROS GRANDES

cód.				€	
08103	3 m	16 mm	12	11,45	5,50
08104	5 m	19 mm	12	15,30	6,30
08105	5 m	25 mm	6	19,60	7,90
08108	8 m	25 mm	6	23,90	9,50

## METRICA FLASH TOUCH

CE II

- Design ergonómico
- Numeração clara e visível
- Corpo ABS revestido em borracha resistente aos choques



cód.				€	
08963	3 m	16 mm	12	10,15	5,90
08964	5 m	19 mm	12	13,20	8,95
08965	5 m	25 mm	6	15,90	9,90
08968	8 m	25 mm	6	23,85	14,90
08970	10 m	25 mm	6	29,40	17,25

## METRIC4 XL 27 PLUS

CE II

- Fita 27 mm de largura
- Superfície de fita texturizada
- Revestimento mais espesso em **Nylon**
- **10 x** mais resistente à abrasão

SUPERFÍCIE TEXTURIZADA  
RESISTÊNCIA SUPERIOR  
À ABRASÃO

ZOOM  
10X



cód.				€	€
08765	5 m	27 mm	6	34,45	16,50
08768	8 m	27 mm	6	49,05	21,95

## METRIC4 XL 33

CE II

- Fita 33 mm de largura com revestimento em **Nylon**
- Gancho revestido com grande aderência (**PATENTEADO**)
- Longa duração, anti-abrasão, anti-acido, antirreflexo
- **Super rigidez:** até 3 m na horizontal, e 4,5 m na vertical
- **Numeração de grandes dimensões**
- Caixa bi-material com superfícies revestidas de borracha anti-derrapante e aço inox
- Botão de bloqueio/desbloqueio com amortecedor



cód.				€	€
08755	5 m	33 mm	6	24,65	14,90
08758	8 m	33 mm	6	35,60	21,00

## METRIC4 MAGNETE FORTE

CE II

- Ímã fixo
- Leitura sem erros
- Gancho **magnético forte**
- Revestida a Nylon



cód.				€	€
08597	5 m	25 mm	6	19,05	9,90

## METRIC4 ACTION CHROMED

CE II

- **Dupla graduação**
- Ímã fixo
- Leitura sem erros
- Números de grandes dimensões
- Bloqueio automático



cód.				€	€
08212	3 m	16 mm	6	13,30	7,90
08214	5 m	19 mm	6	17,15	9,80
08215	5 m	25 mm	6	23,55	10,95
08218	8 m	25 mm	6	29,70	13,40

# 2025 PROMOÇÃO

## METRICA 3 STOP ERGO

CE (II)



- Travão intuitivo e ergonômico na parte traseira, segundo travão na parte frontal e botão de bloqueio
- Corpo em borracha anti-choque

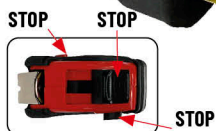

**OFERTA EXPO CUBO**  
PEDIDO SUPERIOR A 84 UNID.

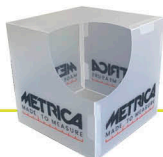

CÓD.	Imagem	Imagem	€	
38643NH	3 m x 16 mm	12	4,60	2,40
38645NH	5 m x 19 mm	12	6,85	3,90
38646NH	5 m x 25 mm	6	8,50	4,35
38648NH	8 m x 25 mm	6	13,10	7,10
38650NH	10 m x 25 mm	6	15,50	8,65

## METRICA 3 STOP

CE (II)



- Travão intuitivo, ergonômico e segundo travão dianteiro
- Corpo em borracha anti-choque

**OFERTA EXPO CUBO**  
PEDIDO SUPERIOR A 84 UNID.



CÓD.	Imagem	Imagem	€	
38653NH	3 m X 16 mm	48	4,60	2,40
38654NH	3 m X 19 mm	48	5,10	2,80
38655NH	5 m X 19 mm	48	6,85	3,90
38656NH	5 m X 25 mm	48	8,50	4,35
38658NH	8 m X 25 mm	12	13,10	7,10
38660NH	10 m X 25 mm	6	15,50	8,65

## METRICA ONE

CE (I)



- Fita extra precisa
- Fita revestida a Nylon de longa duração, anti-abrasão, anti-ácido e antirreflexo
- Caixa cromada revestida com borracha antiderrapante

**DUAS VEZES MAIS PRECISO**

TOLERÂNCIA CE

CLASSE (I) ±mm

5 m

0.60

Nylon COATED



CÓD.	Imagem	Imagem	€	
38736	5 m	25 mm	1	26,10 12,90

## METRICA NEW GRADUATION

CE (II)



- Graduação com linhas de comprimento variável
- Desenho patenteado
- Pontos alternados de 2 em 2 mm



DUPLA GRADUAÇÃO

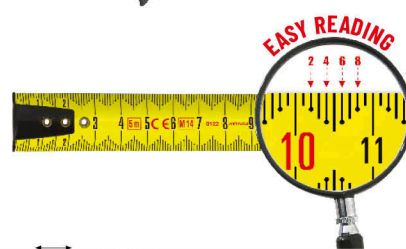

CÓD.	Imagem	Imagem	€	
08665	5 m	25 mm	6	17,25 8,65

## METRICA LOOK

CE (II)



- Leitura direta em interiores
- Caixa ABS robusta
- Com clipe

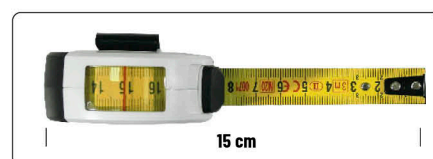

CÓD.	Imagem	Imagem	€	
38264	3 m	16 mm	6	12,50 6,90
38265	5 m	19 mm	6	17,25 9,50

**NEW**

## METRICA SUPER ACTION - FIBRA

CE III

- **Forma ergonómica exclusiva patenteada** facilita a medição sem esforço
- Sistema exclusivo de saída da fita com manivela bloqueada
- Gancho dobrável



CÓD.				€	
40029V	50 m	13 mm	1	73,70	48,00

## METRICA QUICK RETURN 100 M - FIBRA

CE III

- **Rebobinagem 3x mais rápida** (velocidade tripla)
- Sistema de amortecimento da fita no fim da rebobinagem
- Pega confortável com revestimento de borracha anti-derrapante
- Caixa aberta para uma maior limpeza da fita



CÓD.				€	
40027	100 m	13 mm	1	97,35	69,90

## METRICA FORTE - FIBRA

CE III

- Cinta de fibra reforçada com **50 fios**
- **Rebobinagem 3x mais rápida** (velocidade tripla)
- Ponta de borracha antiderrapante



CÓD.				€	
40113	30 m	19 mm	1	52,30	32,30
40115	50 m	19 mm	1	75,85	46,25

## METRICA QUICK RETURN - FIBRA

CE III

- **Pega ergonómica**
- **Rebobinagem 3x mais rápida** (velocidade tripla)
- Base em borracha para fixar no solo sem escorregar



CÓD.				€	
40023V	30 m	13 mm	1	48,50	30,15
40025V	50 m	13 mm	1	60,80	38,75

## SUPER ACTION PLUS TEXTURADO CE II

- Forma ergonómica exclusiva patenteada
- Sistema exclusivo de saída da fita com manivela bloqueada
- Revestimento de Nylon mais grossa para alta protecção da fita
- Resistência à abrasão 10x mais duradoura



CÓD.	50 m	13 mm	1	€	€
39244V	50 m	13 mm	1	193,55	107,00

## METRICA ACTION - STEEL CE II

- Fita de aço esmaltado com revestimento resistente ao desgaste e aos ácidos
- Gancho com Suporte e anel de metálico
- Pega em borracha com revestimento antiderrapante
- Sistema exclusivo de saída da fita com manivela bloqueada



CÓD.	50 m	13 mm	1	€	€
39270V	50 m	13 mm	1	166,15	64,55

## TENDERCOLOR NEW CE II

- Fita de aço
- Numeração de grandes dimensões
- Pega ergonómica em borracha



CÓD.	50 m	13 mm	1	€	€
39262SPB	50 m	13 mm	1	61,30	40,90

## NEW RUBBER TOUCH CE II

- Corpo ABS com efeito Rubber Touch
- Dimensões e peso reduzidos
- Fita de aço
- Anel metálico



CÓD.	30 m	13 mm	1	€	€
39330	30 m	13 mm	1	58,10	34,45
39350	50 m	13 mm	1	97,35	55,95

## 1 - 2 METROS DURALUMÍNIO

CE III

- Duralumínio Preto
- Graduação gravada e oxidada
- Molas em latão tratado

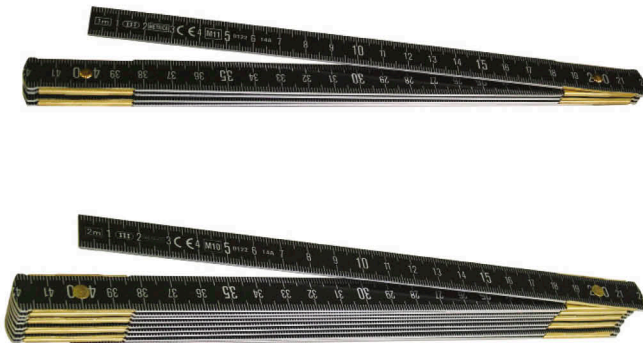

CÓD.			€	
20108	1 m	12	12,90	9,00
21036	2 m	12	25,00	17,90

## METRO DUPLO FIBRA DE VIDRO

CE III

- Graduação gravada
- Com mola dupla anti-desgaste
- Esquadro 90º graus
- Material não condutor, lavável e não risca a superfície

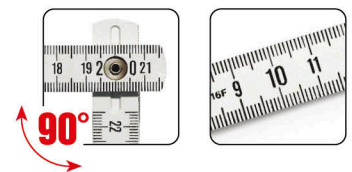
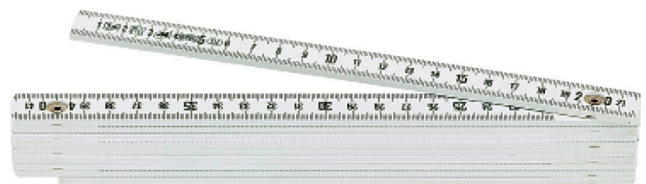

CÓD.			€	
18010	2 m	12	9,70	6,10

## MEDIDORES ESPECIAIS PARA PETANCA

- Barra deslizante de 10 cm com dispositivo de bloqueio para comparações (ideal para árbitros)
- Dobradiças com mola antidesgaste e encaixe a 90º e gravação apenas num lado (Cód. 20136)
- Barra de Alumínio extremamente leve de longa duração (Cód. 20134)



Cód. 20136 (fibra)



Cód. 20134 (alumínio)

CÓD.			€	
20136	1 m	10	15,00	9,90
20134	1 m	10	52,70	31,10

## METRO DUPLO MADEIRA

**NEW**

- Novos modelos em Madeira (faia); mais resistentes à abrasão
- Rebites de aço (invisíveis)
- Graduação dupla em milímetros

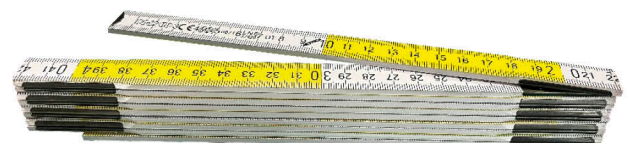

CÓD.			€	
23122AN	2 m	10	6,35	3,95
23123AN	2 m	10	6,35	3,95

## LÁPIS GRAFITE

- Escreve em todas as superfícies (exceto vidro)
- Material **100% grafite**
- Escreve **10x mais** do que um lápis tradicional
- Ponta sempre pronta, sem afiar
- **Não suja as mãos**
- Resistente ao impacto e quebra

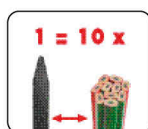
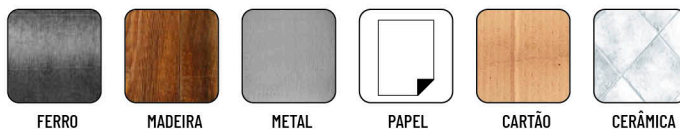

CÓD.			€	
51150	1 pcs	12	6,20	3,90
51151	blister 2 pcs	1	14,05	7,80

Caixa 36 pcs em plexiglass

CÓD.			€	
89206	box 36 pcs	1	221,45	140,40

## AFIA

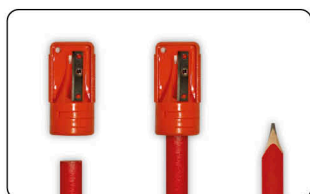

CÓD.			€	
49159	10		4,20	2,35

## LÁPIS DE CARPINTEIRO 18 - 30 CM

- Mina preto HB
- Preço por unidade

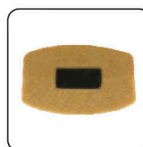

CÓD.	L		€	
51050N	18 cm	1	0,70	0,49
51020	30 cm	1	1,75	1,12

Em caixas de 144 unidades / preço por unidade

## LÁPIS DE CARPINTEIRO 30 CM - BLISTER

- Blister com 3 pcs



CÓD.			€	
50390	6		10,65	5,85

Preço por blister / Em caixa de 6 blisters

## LÁPIS INDUSTRIAL

- Lápis para a indústria e construção
- Corpo em baquelite preto
- Botão de metal
- Diâmetro da mina preta **5,5 mm**



CÓD.			€	
51080	1		7,60	5,90
01090	1		6,20	3,55



## LÁPIS DE ALVENARIA

- Mina dura preta
- Forma plana e oval para um melhor manuseamento



CÓD.			€	
51060	L 24 cm	1	1,25	0,75
51070	L 30 cm	1	1,85	1,10

Em caixas de 144 unidades / preço por unidade

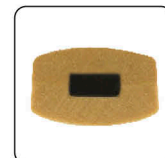

## SPRAY MARCADOR FOLLOW ME 500ml

- Marcador para construção
- Válvula de auto-limpeza
- Tampa de bloqueio de segurança
- **Cores fluorescentes - não permanentes**
- Para marcação de qualquer superfície, mesmo húmida (betão, asfalto, pedra, relva, areia, etc.)
- **Sem chumbo e sem CFC**

### DISPOSITIVO DE SEGURANÇA

FECHADO

ABERTO



CÓD.			€	
50181EU	●	12	10,50	6,10
50182EU	●	12	10,50	6,10
50183EU	●	12	10,50	6,10
50184EU	●	12	10,50	6,10
50185EU	●	12	10,50	6,10
50186EU	●	12	10,50	6,10



APLICAÇÃO VERTICAL

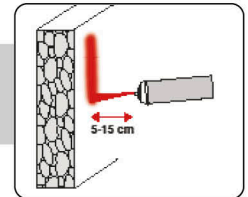

APLICAÇÃO HORIZONTAL

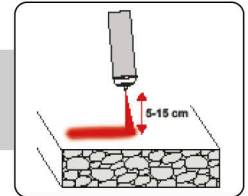

UTILIZAÇÃO AO CONTRÁRIO

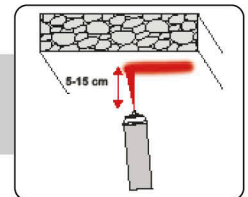

## TRAÇADOR GIGANTE EM ABS

- Marcador Profissional recarregável para obras
- Inclui **corda de 50 M** - diâmetro 3 mm e alta resistência (55 kg)
- Capacidade total 400 gr

CÓD.			€	
60097	L 50 m	6	86,05	50,25

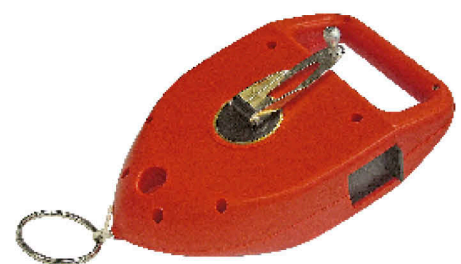

## FRASCOS DE PÓ



CÓD.		GR.	€	
60133	●	400	8,20	4,60
60113	●	400	8,20	4,60
60127	●	1000	14,80	8,25
60128	●	1000	14,80	8,25
60141	●	3500	39,80	25,00
60140	●	3500	39,80	25,00

## FITA DE SINALIZAÇÃO

- Comprimento 100 m

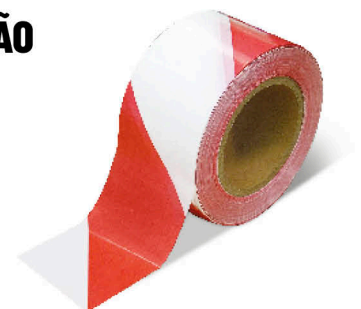

CÓD.		€	
60132	H 50 mm	3,95	2,10
60122	H 70 mm	5,05	2,75

## "ALL BLACK" - 18 MM X-ACTO UNIVERSAL

- Corpo em ABS
- Lâmina 18 x 0,7 mm



**sk2**  
HRC ≥ 67

cód.			€	
<b>09031</b>	L 160 mm	12	<b>8,40</b>	<b>6,50</b>

## "ALL BLACK" - 18 MM X-ACTO COM RODA DE BLOQUEIO

- Corpo em ABS
- Lâmina 18 x 0,7 mm
- Profissional



**sk2**  
HRC ≥ 67

**60kg**  
SELF LOCKING FORCE

cód.			€	
<b>09033</b>	L 185 mm	12	<b>12,85</b>	<b>9,50</b>

## "ALL BLACK" HEAVY DUTY - 18 MM X-ACTO COM RODA DE BLOQUEIO

- Corpo metálico com borracha
- Lâmina 18 x 0,7 mm
- Profissional



**sk2**  
HRC ≥ 67

**60kg**  
SELF LOCKING FORCE

cód.			€	
<b>09039</b>	L 185 mm	12	<b>18,75</b>	<b>13,70</b>

## LÂMINAS

- Recarga de 10 Lâminas 18 x 0,7 mm

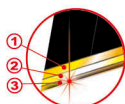
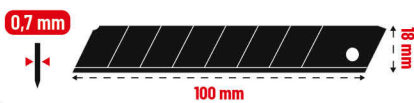

LÂMINAS 50% MAIS AFIADAS TRIPLO ÂNGULO DE CORTE

**sk2**  
HRC ≥ 67



cód.			€	
<b>49058</b>	100 x 18 x 0,7 mm	10	<b>10,65</b>	<b>5,30</b>

## "ALL BLACK" - 9 MM X-ACTO COM RODA DE BLOQUEIO

- Corpo em ABS
- Lâmina 9 x 0,7 mm



**sk2**  
HRC ≥ 67

cód.			€	
<b>09069</b>	L 140 mm	12	<b>10,80</b>	<b>7,75</b>

## LÂMINAS - 9 MM

- Recarga de 10 Lâminas 9 x 0,7 mm

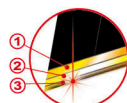
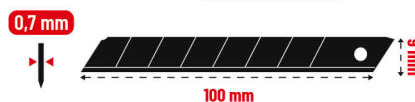

LÂMINAS 50% MAIS AFIADAS TRIPLO ÂNGULO DE CORTE

**sk2**  
HRC ≥ 67



cód.			€	
<b>49029</b>	100 x 9 x 0,7 mm	10	<b>5,20</b>	<b>3,65</b>

## "BLACK BULL" - 25 MM X-ACTO COM RODA DE BLOQUEIO

- Lâmina 25 x 0,7 mm
- Profissional

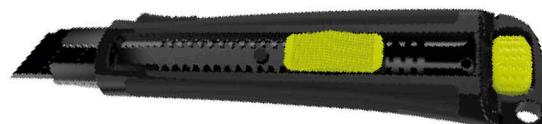

**sk2**  
HRC ≥ 67

**60kg**  
SELF LOCKING FORCE

cód.			€	
<b>09037</b>	L 200 mm	12	<b>22,60</b>	<b>11,25</b>

## LÂMINAS

- Recarga de 10 Lâminas 25 x 0,7 mm

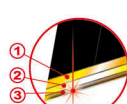
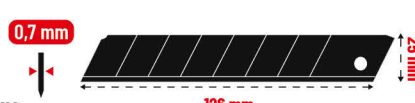

LÂMINAS 50% MAIS AFIADAS TRIPLO ÂNGULO DE CORTE

**sk2**  
HRC ≥ 67



cód.			€	
<b>49039</b>	126 x 25 x 0,7 mm	12	<b>14,55</b>	<b>8,20</b>

## "EL MONOLITO" - 1 MM X-ACTO METRICA ONE

- Lâminas extra grossas e ultra resistentes de **1 mm**
- Corpo em **ABS**
- Bloqueio automático

**NEW**



**sk2**  
HRC ≥ 67



**BOTÃO PARA FACILITAR A TROCA DE LÂMINAS**

### LÂMINAS

- Recarga 7 Lâminas
- **100 x 18 x 1 mm**

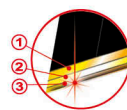
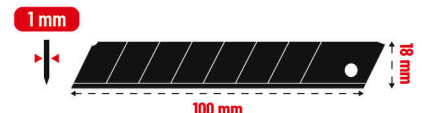

LÂMINAS 50% MAIS AFIADAS TRÍPLIO ÂNGULO DE CORTE

**sk2**  
HRC ≥ 67



CÓD.			€
<b>09036</b>	L 140 mm	12	<b>19,25 13,50</b>

CÓD.			€
<b>49068</b>	100 x 18 x 1 mm	12	<b>8,30 5,80</b>

## X-ATO METRICA UTILITY

- Lâmina "ALL BLACK" de **0,6 mm SK2**
- Ajustável em 3 posições e dobrável (apenas 11 cm quando fechado)
- Com clipe para cinto
- Corpo Metálico de cor **fluorescente** para facilitar a visibilidade
- **Descarnador de fio**
- Substituição rápida de lâminas



**NEW**

**sk2**  
HRC ≥ 67

**POSIÇÕES AJUSTÁVEIS**

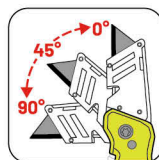

### LÂMINAS "ALL BLACK"

- Recarga de 10 Lâminas Trapezoidais **SK2**

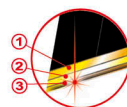
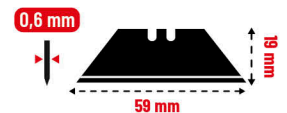

LÂMINAS 50% MAIS AFIADAS TRÍPLIO ÂNGULO DE CORTE

**sk2**  
HRC ≥ 67



CÓD.			€
<b>09080</b>	175 ou 115 mm	12	<b>20,35 14,50</b>

CÓD.			€
<b>49043</b>	59 x 19 x 0,6 mm	10	<b>4,35 2,95</b>

## "ZEBRA" - 18 MM X-ACTO DE BOLSO

- Corpo em **ABS**
- Lâmina 18 x **0,7 mm**



**sk2**  
HRC ≥ 67



### LÂMINAS

- Recarga de 10 Lâminas **18 mm x 0,7 mm**

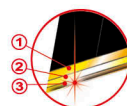
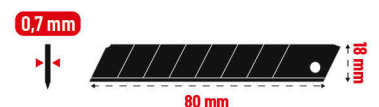

LÂMINAS 50% MAIS AFIADAS TRÍPLIO ÂNGULO DE CORTE

**sk2**  
HRC ≥ 67



CÓD.			€
<b>09025</b>	L 140 mm	12	<b>8,10 5,90</b>

CÓD.			€
<b>49064</b>	80 x 18 x 0,7 mm	10	<b>7,55 5,50</b>

## X-ATO METRICA - 18 MM

- Corpo em **ABS**
- Lâmina 18 x 1 mm
- **Bloqueio automático**



**BOTÃO PARA FACILITAR A TROCA DE LÂMINAS**



CÓD.			€
49065	L 170 mm	24	4,40 3,20



Cód. 89365 contem 24 X-Atos 49065

CÓD.			€
89365	100 x 18 x 1 mm	1	105,40 76,00

## OPEN&CUT - 18 MM X-ACTO METRICA

- Corpo em **ABS**
- Lâmina 18 x 0,7 mm
- Inclui 2 Lâminas de substituição incorporadas



### LÂMINAS

- Recarga 10 Lâminas 18 x 0,7 mm

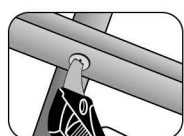
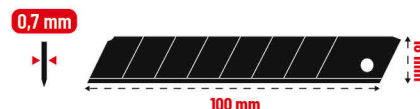

PARAFUSO

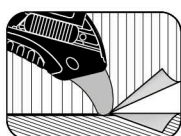

ALCATIFA



LÂMINAS 50% MAIS AFIADAS TRIPLO ÂNGULO DE CORTE



CÓD.			€
09068	L 170 mm	12	10,65 6,20

CÓD.			€
49058	100 x 18 x 0,7 mm	10	10,65 5,30



## EXPOSITOR COMPLETO A



CÓD.		
89363	09031	12
	49058	10
	09069	12
	49029	10
	09036	12
	49068	12
	09080	12
	49043	10
	<b>695,60</b>	

€

## EXPOSITOR COMPLETO B



CÓD.		
89364	09033	12
	49058	10
	09037	12
	49039	12
	09025	12
	49064	10
	09068	12
	49058	10
	<b>653,60</b>	

€

## PAQUÍMETRO DE RELÓGIO DIGITAL (HD) IP 67

- **Visor digital (HD)** a cores com indicação e ponteiro digital de fácil leitura
- Intensidade de visualização ajustável
- Superfícies de medição endurecidas
- **Bateria Li-ion recarregável**
- Inclui Estojo com Cabo de carga
- Leitura **0,01 mm**
- Grau de Proteção **IP 67**  
Resistente a água e poeiras

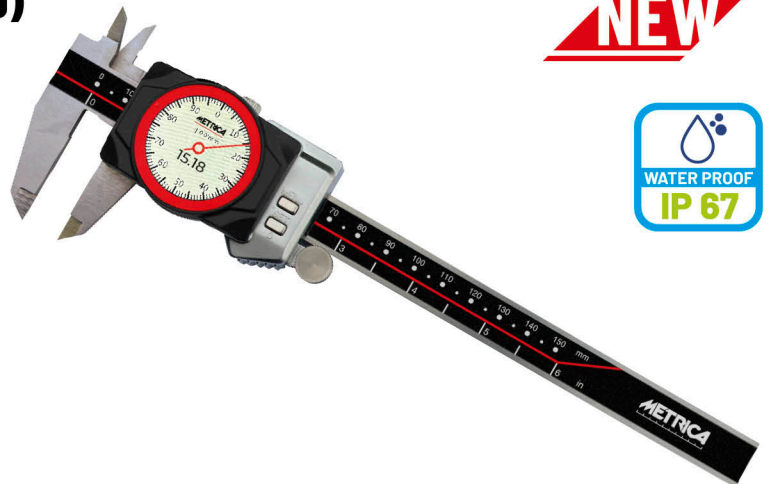

**NEW**



CÓD.			€
10029	0 - 150 mm	1	160,25 100,50

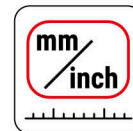

## PAQUÍMETRO DIGITAL PROFSSIONAL

**NEW**



- Aço inox endurecido
- Nova estrutura do visor de vidro para uma maior estabilidade e precisão
- 4 funções de medição
- Leitura **0,01 mm**

CÓD.			€
10026	0 - 150 mm	1	85,10 45,70
10027	0 - 200 mm	1	105,60 58,45

## PAQUÍMETRO OFICINA



- Aço cromado
- Escala cromada mate
- Parafuso de bloqueio
- 4 funções de medição
- Leitura **0,02 mm**  
**1/1000 inch**

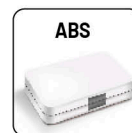

CÓD.	A mm	B mm	mm		€
10075	0 - 150	40	0,02	1	35,95 28,10

## PAQUÍMETRO OFICINA



- Aço inox endurecido
- Escala cromada mate
- Sistema de travão por alavanca
- 4 Funções de medição
- Leitura **0,05 mm**  
**1/128 inch**



CÓD.	A mm	B mm	mm		€
10039	0 - 155	40	0,05	5	26,55 16,95

## PAQUÍMETRO TIPO ESCOLA



- Aço inox temperado
- Escala cromada mate
- Sistema de travão por alavanca
- 4 Funções de medição
- Leitura **0,05 mm**  
**1/128 inch**



CÓD.	A mm	B mm	mm		€
10038	0 - 150	40	0,05	5	23,80 15,90
10031	0 - 200	40	0,05	1	36,50 23,80

## PAQUÍMETRO DIGITAL FIBRA CARBONO

- Fibra Carbono
- Números gigantes
- Leitura **0,1 mm** (Apenas leitura em milímetros)

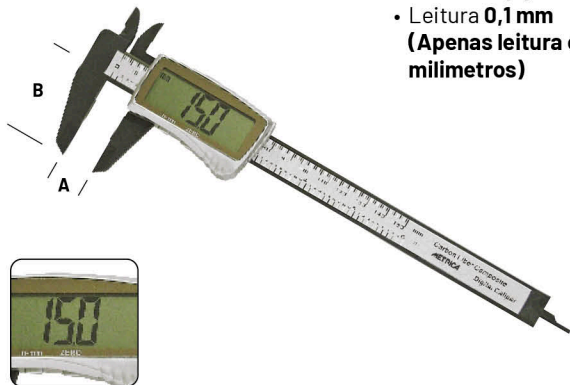

CÓD.	A mm	B mm	mm		€
10745	0-150	40	0,1	5	28,40 12,50

## PAQUÍMETRO DIGITAL NÚMEROS GIGANTES

- Aço Inox endurecido
- Números gigantes (11 mm)
- 4 Funções de medição
- Leitura **0,01 mm** **0,0005 inch**



CÓD.	A mm	B mm	mm		€
10017	0-150	40	0,01	1	59,70 38,75

## PAQUÍMETRO DIGITAL IP 65

- Aço inox endurecido
- 4 Funções de medição
- Leitura  $\pm 0,01$  mm **0,0005 inch**
- Grau de Proteção **IP 65** Impermeável a jatos de água e poeira



CÓD.	A mm	B mm	mm		€
10001	0-150	40	0,01	1	139,25 64,55

## PAQUÍMETRO DIGITAL IP 67

- Aço inox endurecido
- 4 Funções de medição
- **Norma DIN 862**
- Leitura **0,01 mm** **0,0005 inch**
- Grau de Proteção **IP 67** Impermeável e resistente a óleos, poeiras e partículas metálicas



CÓD.	A mm	B mm	mm		€
10018	0-150	40	0,01	1	154,35 110,00

## PAQUÍMETRO DIGITAL NÚMEROS GIGANTES

- Aço inox endurecido
- Números gigantes (11 mm)
- 4 Funções de medição
- Leitura **0,01 mm** **0,0005 inch**



CÓD.	A mm	B mm	mm		€
10009	0-300	50	0,01	1	148,40 99,00

## PAQUÍMETRO DIGITAL WIRELESS IP 54

- Preparado para **transmissão de dados**
- Aço inox endurecido
- Ecrã LCD alta visibilidade
- 4 Funções de medição
- **Norma DIN 862**
- Leitura **0,01 mm** **0,0005 inch**
- Grau de Proteção **IP 54**



CÓD.	A mm	B mm	mm		€
10081	0-150	40	0,01	1	152,20 105,00

## PAQUÍMETRO PRECISÃO

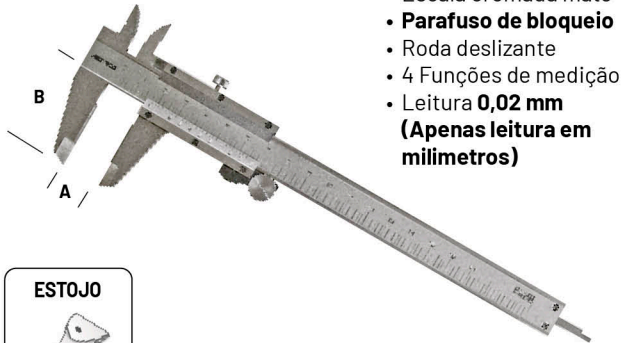

- Aço inox endurecido
- Escala cromada mate
- **Parafuso de bloqueio**
- Roda deslizante
- 4 Funções de medição
- Leitura **0,02 mm**  
**(Apenas leitura em milímetros)**



CÓD.	A mm	B mm	mm		€
<b>10055</b>	0-155	40	0,02	1	<del>49,40</del> 36,00

## PAQUÍMETRO PRECISÃO MONOBLOCO

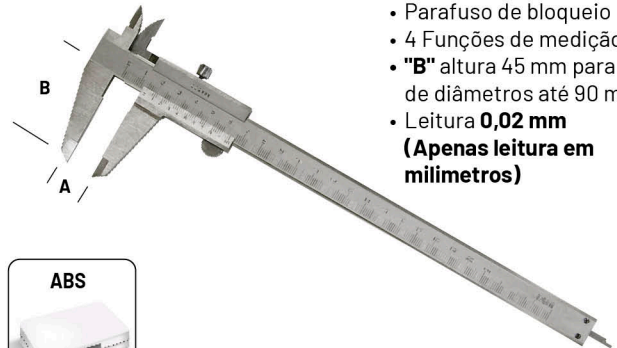

- Aço inox endurecido
- **Monobloco**
- Parafuso de bloqueio
- 4 Funções de medição
- "B" altura 45 mm para medição de diâmetros até 90 mm
- Leitura **0,02 mm**  
**(Apenas leitura em milímetros)**



CÓD.	A mm	B mm	mm		€
<b>10058</b>	0-200	45	0,02	1	<del>69,90</del> 52,00

## PAQUÍMETRO COM RELÓGIO



- Aço inox endurecido
- Escala cromada mate
- **Parafuso de bloqueio**
- Roda deslizante
- Possibilidade de repor a "0" em qualquer posição
- 4 Funções de medição

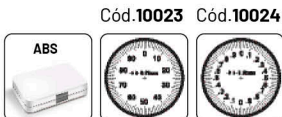

Cód.10023 1 volta = 1 mm Resolução 0,01 mm  
Cód.10024 1 volta = 2 mm Resolução 0,02 mm

CÓD.	A mm	B mm	mm		€
<b>10023</b>	0-150	40	0,01	1	<del>75,85</del> 56,00
<b>10024</b>	0-200	50	0,02	1	<del>108,10</del> 79,00

## MICROMETRO PROFUNDIDADE

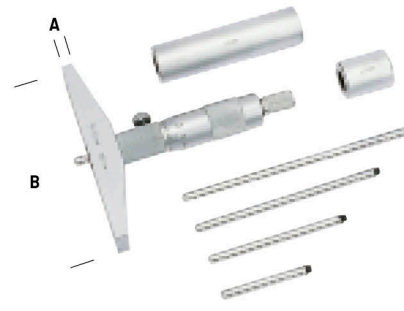

- Largura base **100 mm**
- **Norma DIN 863**
- Leitura **0,01 mm**



CÓD.	A mm	mm		€
<b>44090</b>	0-100	0,01	1	<del>152,70</del> 112,00
<b>44091</b>	0-200	0,01	1	<del>279,60</del> 208,00

## MICROMETRO EXTERIORES



- Arco cromado
- Pontas Metal Duro  $\varnothing$  **6,5 mm**
- Tambor  $\varnothing$  **18 mm**
- Alavanca de bloqueio
- **Norma DIN 863**
- Leitura **0,01 mm**



CÓD.	A mm	mm		€
<b>44061</b>	0-25	0,01	1	<del>49,15</del> 36,50
<b>44062</b>	25-50	0,01	1	<del>51,00</del> 37,90
<b>44063</b>	50-75	0,01	1	<del>55,95</del> 41,60
<b>44064</b>	75-100	0,01	1	<del>66,15</del> 49,20

## MICROMETRO EXTERIORES

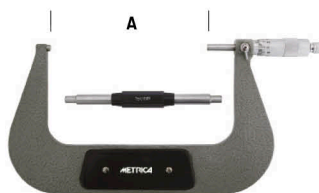

- Arco pintado
- Pontas Metal Duro  $\varnothing$  **6,5 mm**
- Tambor  $\varnothing$  **18 mm**
- Alavanca de bloqueio
- **Norma DIN 863**
- Leitura **0,01 mm**



CÓD.	A mm	mm		€
<b>44065</b>	100-125	0,01	1	<del>76,90</del> 57,20
<b>44066</b>	125-150	0,01	1	<del>88,75</del> 66,00
<b>44067</b>	150-175	0,01	1	<del>93,05</del> 69,20

## COMPARADOR PRECISÃO Ø 58

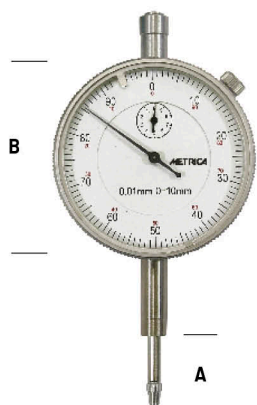

- Relógio ajustável com parafuso de bloqueio
- Índice de tolerância
- Leitura **0,01 mm**



CÓD.	A mm	B mm	mm		€
<b>41019</b>	0-10	Ø 58	0,01	1	<b>32,40 22,70</b>

## COMPARADOR PRECISÃO Ø 58

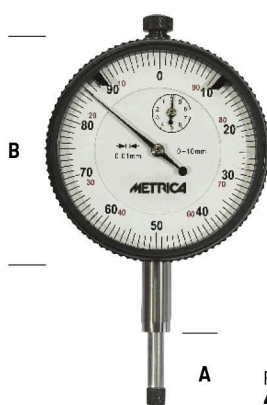

- Comparador de alta sensibilidade e desenho robusto
- Relógio ajustável com indicador de tolerância
- Precisão segundo **DIN 878**
- Leitura **0,01 mm**
- Inclui Prato

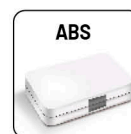

CÓD.	A mm	B mm	mm		€
<b>41020</b>	0-10	Ø 58	0,01	1	<b>65,60 48,00</b>

## BASE MAGNÉTICA



- 3 braços de secção robusta
- Ajuste rápido
- Base prismática
- Interruptor ON/OFF
- Capacidades:  
**45 Kg** (Cód. 46015)  
**60 Kg** (Cód. 46010)
- Vendido sem Comparador

CÓD.	H mm	Kg		€
<b>46010</b>	230	60	1	<b>60,25 39,00</b>
<b>46015</b>	230	45	1	<b>59,70 44,40</b>

## MEDIDOR ESPESSURAS

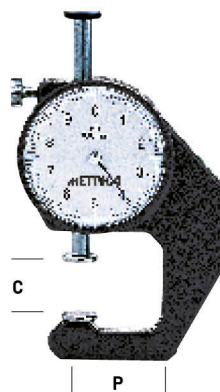

- Suporte em Alumínio com pintura anti-deslizante
- Parafuso de bloqueio
- Leitura **0,01 mm**



CÓD.	C mm	P mm	mm		€
<b>43051</b>	0-10	20	0,1	1	<b>115,10 85,60</b>
<b>43052</b>	0-20	20	0,1	1	<b>120,45 89,60</b>

## CONTA FIOS (WHITWORTH / MÉTRICO)



- Inclui 52 Lâminas

CÓD.	N			€
<b>35020</b>	52	Whitwh SI	5	<b>11,70 8,70</b>

## MEDIDOR

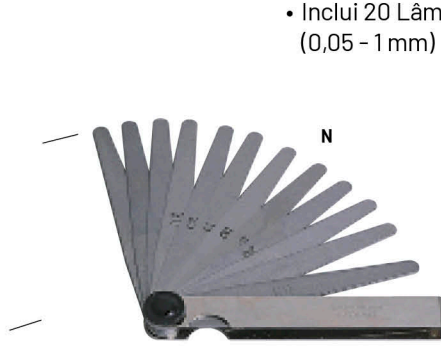

- Inclui 20 Lâminas 100 mm (0,05 - 1 mm)

CÓD.	S mm	L mm	N		€
<b>35102</b>	0,05 ÷ 1	100	20	5	<b>7,40 5,50</b>

## TRANSFERIDOR ÂNGULOS

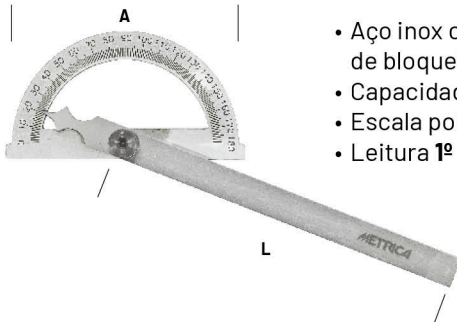

- Aço inox com parafuso de bloqueio
- Capacidade 0 - 180
- Escala polida
- Leitura 1º

CÓD.	A mm	L mm		€	
36511	Ø 80	120	1	30,65	22,80
36512	Ø 120	150	1	36,35	25,75
36513	Ø 150	200	1	43,80	32,00
36514	Ø 200	250	1	54,85	40,80

## GONIÓMETRO UNIVERSAL

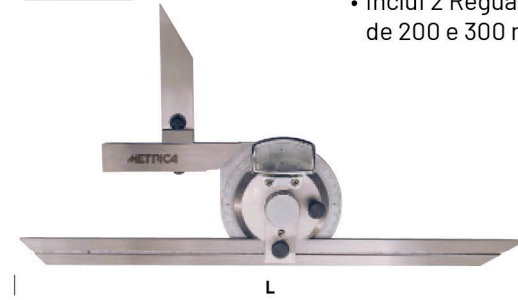

- Aço inox
- Escala graduada
- Leitura **direta com lupa**
- Medição de **ângulos pequenos**
- Inclui 2 Régua deslizes de 200 e 300 mm

CÓD.	L mm		€	
36030	200-300	1	160,25	119,20

## ESQUADRO CARPINTEIRO

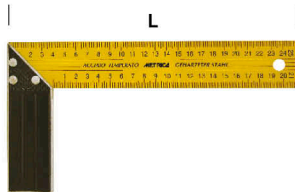

- Aço temperado
- Folha amarela graduada
- Base de alumínio fundido

CÓD.	L mm		€	
29240	150	5	4,30	3,15
29241	200	5	4,75	3,50
29242	250	5	5,00	3,70
29243	300	5	5,65	4,20
29244	350	5	6,50	4,80
29245	400	5	7,20	5,30
29247	500	5	9,55	7,10

## ESQUADRO CARPINTEIRO

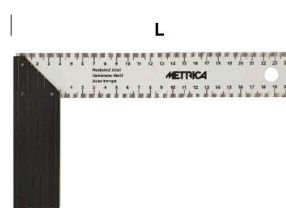

- Aço temperado
- Folha branca graduada
- Base de alumínio anodizado preto

CÓD.	L mm		€	
29252	200	5	16,75	12,45
29253	250	5	17,75	13,20
29254	300	5	18,40	13,60
29255	350	5	21,00	15,60
29256	400	5	22,80	16,90
29257	500	5	26,75	19,80

## ESQUADRO SIMPLES

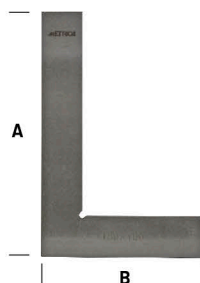

- Aço não temperado
- Secção robusta
- Precisão 1/50 mm

CÓD.	A X B mm		€	
29076	200 x 130	1	25,75	19,00
29077	250 x 165	1	38,95	28,90
29078	300 x 200	1	53,80	39,95
29079	400 x 250	1	89,25	66,40
29080	500 x 330	1	128,50	95,60

## ESQUADRO COM ABA

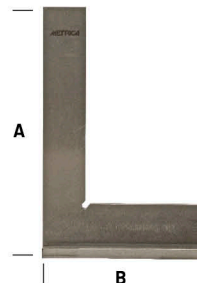

- Aço não temperado
- Secção robusta
- Precisão 1/50 mm

CÓD.	A X B mm		€	
29166	200 x 130	1	43,70	32,40
29167	250 x 165	1	55,95	41,60
29168	300 x 200	1	64,00	47,60
29169	400 x 250	1	102,70	76,00
29170	500 x 330	1	154,85	115,00

## COMPASSO COM MOLA

- Abertura rápida
- Série pesada com **secção quadrada**
- Pontas retas em aço temperado

SECÇÃO

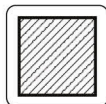

CÓD.	L mm		€	
48013	150	2	14,30	10,65
48014	175	2	15,85	11,80
48015	200	2	17,20	12,80
48016	250	2	20,85	15,50
48017	300	2	25,00	18,60

## COMPASSO COM MOLA PARA EXTERIORES

- Abertura rápida
- Série pesada com **secção quadrada**
- Pontas retas em aço temperado

SECÇÃO

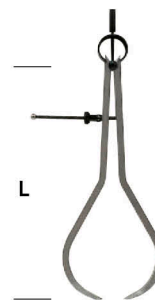
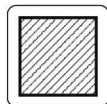

CÓD.	L mm		€	
48023	150	2	14,30	10,65
48024	175	2	15,85	11,80
48025	200	2	17,65	13,10
48026	250	2	20,85	15,50
48027	300	2	25,00	18,60

## COMPASSO COM MOLA PARA INTERIORES

- Abertura rápida
- Série pesada com **secção quadrada**
- Pontas retas em aço temperado

SECÇÃO

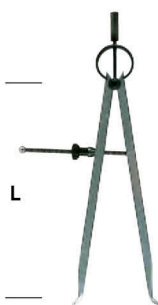
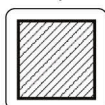

CÓD.	L mm		€	
48033	150	2	14,30	10,65
48034	175	2	15,85	11,80
48035	200	2	17,65	13,10
48036	250	2	20,85	15,50
48037	300	2	25,00	18,60

## COMPASSO SIMPLES

- Pontas retas em aço temperado
- **Secção quadrada**
- Modelo robusto

SECÇÃO

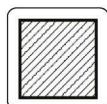

CÓD.	L mm		€	
48002	150	2	16,75	12,45
48003	200	2	18,45	13,75
48004	250	2	25,75	18,75
48005	300	2	30,15	22,25

## JOGO NUMERÁRIOS

- 9 pcs

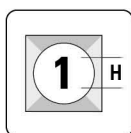

CÓD.	H mm		€	
70152	2	1	6,00	4,45
70154	3	1	7,00	5,20
70155	4	1	7,80	5,80
70156	5	1	9,20	6,85
70157	6	1	12,10	9,00
70158	8	1	19,60	14,60
70159	10	1	31,40	23,40

## JOGO ABECEDÁRIOS

- 27 pcs

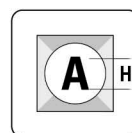

CÓD.	H mm		€	
70102	2	1	23,60	17,55
70104	3	1	23,95	17,85
70105	4	1	24,70	18,40
70106	5	1	29,40	21,85
70107	6	1	36,80	27,40
70108	8	1	66,15	49,20
70109	10	1	95,70	71,20

## PERFILÓMETRO

- Aço
- Para o levantamento de perfis
- Agulhas móveis
- Embalagem blister

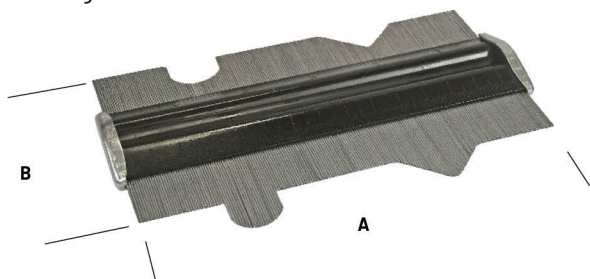

CÓD.	A mm	B mm		€
<b>72001</b>	150	85	1	<b>13,45</b> <b>9,40</b>

## PERFILÓMETRO PROFISSIONAL

- Aço temperado
- Para o levantamento de perfis
- Agulhas móveis

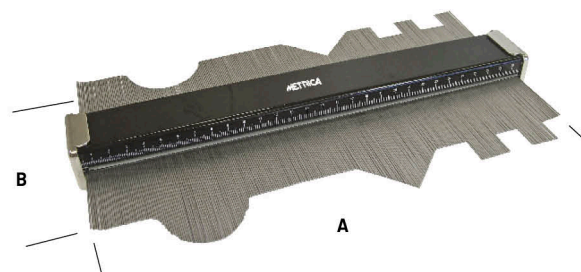

CÓD.	A mm	B mm		€
<b>72002</b>	300	150	1	<b>118,85</b> <b>79,90</b>

## PISTOLA DE SILICONE

- Punho de Alumínio
- Fuso galvanizado
- Para cartuchos de 300 ml e ø 50 mm



CÓD.		€
<b>68250</b>	12	<b>4,70</b> <b>3,70</b>

## PISTOLA DE SILICONE PROFISSIONAL

- Punho de Alumínio fundido
- Corpo em alumínio
- Para cartuchos de 300 ml e ø 50 mm



CÓD.		€
<b>68255</b>	12	<b>13,60</b> <b>9,60</b>

## SUPORTE MAGNÉTICO

- Indicado para soldadura, montagem ou fixação
- Imans em todos os lados
- Embalagem blister



Cód. 60305

Cód. 60304

Cód. 60300

CÓD.	A x A mm		€
<b>60300</b>	85 x 85	1	<b>8,00</b> <b>5,70</b>
<b>60304</b>	110 x 110	1	<b>9,25</b> <b>6,50</b>
<b>60305</b>	135 x 135	1	<b>12,70</b> <b>9,00</b>

## VENTOSAS

- Punho de borracha
- Diâmetro da ventosa **120 mm**
- Bloqueio por alavanca com uma mão (Cód. 50541)



Cód. 50541

Cód. 50543

Cód. 50545

CÓD.	KG.	Ø mm		€
<b>50541</b>	25	120	1	<b>12,05</b> <b>7,50</b>
<b>50543</b>	50	120	1	<b>23,95</b> <b>15,25</b>
<b>50545</b>	75	120	1	<b>26,10</b> <b>17,35</b>

# METRICA

Metrica S.p.A.

Via Grandi, 18 - 20097 San Donato Milanese (MI) - Italia - Tel. +39 02 518981 - export@metrica.it

METRICA.IT

## DISPLAY LINEAR

• 250 x 100 x 55 cm



## DISPLAY AUTOL

• 200 x 45 x 30 cm



## DISPLAY VITRINA

• 178 x 38 x 38 cm



## DISPLAY TOWER

• 160 x 32 cm



REVENDEDOR AUTORIZADO:

IMPORTADOR EXCLUSIVO

**gomsiparts**  
equipamentos industriais, lda.

ZONA INDUSTRIAL DA CORUJEIRA  
RUA 3 Nº 104 - APARTADO 802  
4520 - 622 S. JOÃO DE VÊR - VFR

T. +351 256 371 010  
F. +351 256 371 019

CHAMADA PARA A REDE FIXA NACIONAL



10 ANOS  
CONSECUTIVOS  
2014 - 2023

WWW.GOMSIPARTS.PT  
GERAL@GOMSIPARTS.PT

TODOS OS PREÇOS E CARACTERÍSTICAS TÉCNICAS DETALHADAS NESTE FOLHETO PODEM SER ALTERADAS SEM AVISO PRÉVIO.  
RESSALVAM-SE EVENTUAIS ERROS TIPOGRÁFICOS OU DE IMPRESSÃO.  
IMAGENS NÃO CONTRATUAIS.

CAMPANHA VÁLIDA ATÉ 31 DE DEZEMBRO 2025.

LIMITADO AO STOCK EXISTENTE CONSULTE ESTA E OUTRAS CAMPANHAS NO NOSSO WEBSITE.

